



CAL FIRE



Fireside Collection

2024 - 2025

Major UK Wholesaler of
Fireside Accessories, Service
& Maintenance Products

Stove Glass	Page 3
Cleaning & Restoration	Pages 4 - 7
Stove Rope & Tapes	Pages 8 - 10
Service & Installation	Pages 11 - 16
Firelighters	Page 17
Stove Bright Paint	Pages 18 - 19
Ecofans	Pages 20 - 22
Colour Matching Accessories	Pages 23 - 24
Coal Buckets	Pages 25 - 27
Kindling & Log Baskets	Pages 28 - 31
Log Carriers & Racks	Pages 32 - 37
Tools & Accessories	Pages 38 - 41
Hearth Tidies & Bellows	Pages 42 - 43
Companion Sets	Pages 44 - 48
Nursery Guards & Fireguards	Pages 49 - 51
Classic Firescreens	Pages 52 - 55
Castings	Pages 56 - 61
Firebaskets	Pages 62 - 66
Frets & Solid Fuel	Pages 67 - 71
Fenders	Pages 72 - 75
Homewares	Pages 76 - 77
Outdoor Range	Page 78

CALFIRE supply to trade accounts all over the Country, however members of the public are welcome to browse through this catalogue or visit the companies website at www.calfire.com. Contact with the company can be made through an email facility where product information or details of local stockists can be ascertained.

Alternatively contact your stockist or telephone our friendly staff on **01691 772922**

Please note that specified finishes such as Brass, Antique, Chrome, Pewter, Copper, Copper Bronze & Steel relate to the colour only and not the material.



Throughout pages 3-78 of this catalogue, British Manufactured items are clearly indicated with the union flag for your information.

Fireside Products listed in this catalogue are either manufactured using Mild Steel and or Cast Iron.

Due to studio lighting and printing inks, the colours shown in this catalogue may differ slightly from those of the actual products. Any dimensions or weights given are approximate and should only be used as a guide. Key to dimensions: H=Height; D=Depth; W=Width; L=Length. Calfire's aim is one of constant improvement and the company reserves the right to change specifications without written notice. Reproduction of the photographs in this catalogue is prohibited without the prior written permission from Calfire Ltd.

Stove Glass

Stove Glass Panels, Strips & Mica



Panels

Calfire Panels are manufactured from the finest quality Schott Robax® Near-zero Thermal expansion rated ceramic glass. Sizes are available from stock for all leading stoves and our in-house cutting facility means any size and shape can be quickly supplied to order.

Mica

Ready cut stove panels and standard sheets are available.



Curved Panels

We now stock a selection of curved panels for some popular stoves. Please refer to our price list for more details.

Strips

Replacement Strips are supplied from the highest quality 4mm Robax.

Calfire have Strips to suit the majority of stoves on the market and can supply specials with a rapid response guaranteed.

Calfire hold standard size glass panels in stock for all popular stove manufacturers.



We recommend when replacing new glass panels to also replace the thermal rope seal.

Please refer to pages 8, 9 & 10

Dry Wiper



A dry glass cleaner specifically developed by Schott Robax® for cleaning ceramic glass panels.

DRY WIPER x14
13605
Counter Display Box

Please contact us for prices on any special requirements. See our Price List for details.

Stove Glass & Vitreous Enamel Cleaner



13009 500ml

Removes the toughest tar, soot and creosote stains from stove window glass.

Spray-on Stove Glass Cleaner



13011 500ml

Removes the toughest tar, soot and creosote stains from stove window glass.

Fireplace Cleaner



13012 500ml

Removes stains from Stone, Brick and Concrete.

Super Seal



13001 30ml

13002 100ml

13003 500ml

A High temperature adhesive used to secure thermal rope/tape and ceramic fibre seal.

Super Silicone



13004 80ml

Black Silicone Sealant for use where good adhesion and a flexible bond is required with a high temperature resistance to 300c. Used to secure thermal rope/tape and ceramic fibre seal.

Stove Rope Seal



13005 50ml

Clear Ultra -High Temperature adhesive used to secure rope/tape and ceramic fibre seal.

Slate Sheen



13017 500ml

Seals and protects slate, enhancing its natural beauty, repelling dirt and water whilst allowing the slate to breathe.

Flue & Chimney Cleaner



13018 750g

Flue free helps to maintain clean chimneys for maximum efficiency, lower fuel costs and a reduced risk of fire.

Stove & Grate Polish



13019 170g

A water based graphite polish suitable for wood/coal stoves, grates and surrounds.

Slate Oil



13020 100ml

Seals and protects slate, enhancing its natural beauty, repelling dirt and water whilst allowing the slate to breathe.

Coal Paint



04039 400ml

Rejuvenating or adding a decorative finish to ceramic coals.

Cleaning Paste



13021 400g

Glass cleaning paste to be used regularly with a non-metallised abrasive pad or sponge.

Stove & Grate Polish



13504 170g

A water based graphite polish suitable for wood/coal stoves, grates and surrounds.

Black Stove & Grate Polish



13503 75ml tube

A water based graphite polish suitable for wood/coal stoves, grates and surrounds.

Multi-use Metal Polish



13512 150ml tube

A very effective polish for use on copper, brass, nickel, pewter, chrome and gold. Multi-use metal polish gives a cleaner, more protective, longer lasting shine.

Glass Cleaner



13506 320ml aerosol

A foaming formula that will stick to vertical surfaces to dissolve smoke stains and tar/creosote deposits.

Fireplace Cleaner



13510 500ml

Uses Oxygen based bleaching action to remove smoke, soot and tar stains from stone, concrete, marble and other hard surfaces.

Xylene Thinners



13518 125ml

Ideal for use with Stove Bright HT paint. Xylene thinners can be used to clean surfaces, clean brushes and any other equipment that has been used with oil based paints.

Slate Oil



13515 100ml

Seals and protects slate, enhancing it's natural beauty, repelling dirt and water whilst allowing the slate to breathe.

Spray-on Glass Cleaner



13517 750ml spray

This cleaner clings to vertical surfaces to dissolve smoke stains and tar/creosote deposits.

Coal Paint



13516 300ml aerosol

An high temperature paint for applying a decorative finish to new or for rejuvenating old, ceramic coals.

Lint Free Cloths



13519 300 x 300mm Cloths
(Pack of 3)

Machine washable lint cloths. Ideal for applying products such as cleaners, polishes and oils.

Heat Bond



13523 30ml

13524 125ml

A Non-toxic fixative specially formulated for bonding sealing rope onto solid fuel stoves or cookers.

Flue Free Chimney Cleaner



13500 750g

Flue free helps to maintain clean chimneys for maximum efficiency, lower fuel costs and a reduced risk of fire. Now non corrosive to Stainless Steel.

Matt Black Stove Paint



13520 150ml

13521 250ml

13522 450ml

A High Temperature paint for applying to stoves and metal surfaces.

Flue Free Chimney Cleaner



13501 90g

Flue free helps to maintain clean chimneys for maximum efficiency, lower fuel costs and a reduced risk of fire. Now non corrosive to Stainless Steel.

Peek Cream Polish



13600 100ml



Peek is a 4-in-1 cleaner that cleans, polishes, restores and protects 38 surfaces including brass, copper, stainless steel, silver, gold, chrome, fibreglass, ceramics, glass, acrylics and painted surfaces.

Panel Replacement Accessories

Calfire thermal rope seal is fitted to stove and oven doors to provide an air tight seal. Secure with Calfire Super Seal.

Thermal Rope Seal

Supplied in 2 metre packs or 25 metre rolls with thicknesses ranging from 3mm to 25mm. Please note that 2 metre packs with an 'S' suffix include a 50ml Calfire Superseal & 2 metre packs with an 'BS' suffix include a 80ml Calfire Super Silicone. The packs also include a strip of end sealing tape.



	3mm	6mm	8mm	9mm	10mm	12mm	13mm	14mm	15mm	16mm	18mm	25mm
White 2M Pack	10002S 1002BS	10006S 10006BS	10010S 10010BS	N/A	10014S 10014BS	10018S 10018BS	N/A	N/A	10022S 10022BS	N/A	10026	10030
White 10M Pack	N/A	N/A	N/A	N/A	N/A	N/A	N/A	N/A	N/A	N/A	N/A	10032
White 25M Reel	10004	10008	10012	N/A	10016	10020	N/A	N/A	10024	N/A	10028	10033
Black 2M Pack	N/A	10035S 10035BS	10039S 10039BS	10058S 10058BS	10043S 10043BS	10047S 10047BS	10069S 10069BS	N/A	N/A	10067S 10067BS	10066S 10066BS	N/A
Black 25M Reel	N/A	10037	10041	10059	10045	10049	10070	N/A	N/A	10068	10065	N/A
Black Soft 2M Pack	N/A	10050S 10050BS	10052S 10052BS	N/A	10054S 10054BS	10056S 10056BS	10071S 10071BS	10061S 10061BS	N/A	N/A	N/A	N/A
Black Soft 25M Reel	N/A	10051	10053	N/A	10055	10057	10072	10060	N/A	N/A	N/A	N/A



Part numbers with an 'S' suffix include a 50ml Calfire Super Seal and a strip of end sealing tape



Part numbers with an 'BS' suffix include a 80ml Calfire Super Silicone and a strip of end sealing tape

Thermal Rope End Sealing Tape

Tape which prevents thermal rope ends fraying



Standard Roll

10601 White
10602 Black
2.5cm x 10M Roll.

Quick Release Roll

10603 White
10604 Black
2.5cm x 10M Roll.

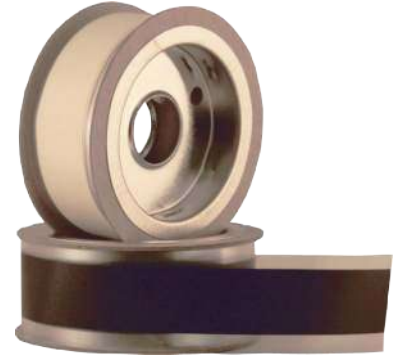

White Thermal Tape - Secure with Calfire Superseal or Calfire Super Silicone.

10510 - 40mm x 2mm x 2 metres

10512 - 40mm x 2mm x 25 metres



White Adhesive Thermal Tape -

10518 - 15mm x 2mm x 2 metre reel

10520 - 15mm x 2mm x 25 metre reel

10526 - 25mm x 2mm x 2 metre reel

10528 - 25mm x 2mm x 25 metre reel



White Thermal Ladder Tape - Calfire ladder tape is used for protecting the edges of glass panels.

10562 - 25mm x 3mm x 2 metres

10564 - 25mm x 3mm x 25 metres



10569 - 20mm x 3mm x 2 metres **P Section**

10570 - 20mm x 3mm x 25metres **P Section**



Black Adhesive Thermal Tape

10571 - 8mm x 3mm x 2 metres

10572 - 8mm x 3mm x 25 metre reel

10542 - 10mm x 2mm x 2 metres

10544 - 10mm x 2mm x 25 metre reel

10546 - 15mm x 2mm x 2 metres

10548 - 15mm x 2mm x 25 metre reel

10573 - 20mm x 2mm x 2 metres

10574 - 20mm x 2mm x 25 metre reel

10580 - 40mm x 2mm x 2 metres

NEW

10581 - 40mm x 2mm x 25 metre reel

NEW



Black Adhesive Thermal Ladder Tape - Calfire ladder tape is used for protecting the edges of glass panels.

10565 - 17mm x 2mm x 2 metres

10566 - 17mm x 2mm x 25 metres



Black Over Braid Thermal Rope - Secure with Calfire Superseal or Calfire Super Silicone.

10063S - 13mm x 2 metres

10063BS - 13mm x 2metres

10062 - 13mm x 25 metres

10064 - 10mm x 3 metres

10073S - 16mm x 2 metres

10073BS - 16mm x 2 metres



Black P Section Bead - **P section** bead is used to create an airtight stove glass seal on specific stoves.

10567 - 10mm x 15mm tail x 0.5 metres

10568 - 10mm x 15mm tail x 2 metres



White P Section Bead - **P section** bead is used to create an airtight stove glass seal on specific stoves.

10575 - 10mm x 10mm tail x 1.5 metres



Ceramic Fibre Seal - Secure with Calfire Superseal or Calfire Super Silicone.

14028 - 6mm x 4mm x 10 metres

14031 - 10mm x 4mm x 10 metres



Wire Reinforced Glass Fibre Seal Black.

10576 - 12mm x 2 metres

10577 - 16mm x 2 metres



Hollow Core Wire Reinforced Glass Fibre Seal Black.

10578 - 14mm x 2 metres



Heat treated Glass Sleeveing.

10579 - 9mm x 2 metres



Fire Cements & Compounds

Mouldable Firebrick



For quick and economical repairs or replacements for firebricks in any heating appliance, stove, open fire, wood burner etc. Tested to 1600°C

12021 5Kg

Premium Fire Cement



Buff Cement
12001 500g
12002 1Kg
12003 2Kg
12025 5Kg



Black Cement
12008 500g
12009 1Kg
12010 2Kg
12026 5Kg



Black Cartridge
12007 310ml

A range of premium ready mixed fire cement. Ideal for patching and repairs to firebricks, fireplaces, solid fuel ovens, boilers and central heating systems. Tested to 1250°C



Heat Resistant Tile Adhesive

Ready-mixed adhesive for fixing tiles in areas subject to high temperatures, such as fire surrounds, behind boilers, cookers and radiators. Resistant to 1000°C.

12023

310ml Cartridge



Heat Resistant Sealant

A ready mixed high temperature sealing and caulking paste for use in fixing and jointing as well as for fire protection. Will withstand up to 1250°C.

12027

310ml Cartridge Beige



Super Silicone 300C

Providing excellent adhesion to most building materials, this product is specifically designed and recommended for high temperature applications up to 300°C.

12024

300ml Cartridge Black



Heat Resistant Silicone 1200C

High performance permanently flexible silicone sealant for all high temperature requirements. Heat resistant to 1200°C, does not harden or crack like fire cement. **This product should not be used near naked flames or hot gases.**

12028 310ml Cartridge Black

12029 310ml Cartridge Clear

NEW

Smoke Pellets

14002 13g (TUBE6) **14061** 5g (TUBE6)
14065 13g (TUB100) **14066** 5g Encapsulated (TUB 10)
14067 5g Encapsulated (TUB 50)



Smoke Matches

14001 CLASSIC (BOX12)



Heat Resistant Gloves



14080 Red

Pair Bagged with header card

14080UB

60 Pairs of un-bagged gloves

14083 Black

Pair Bagged with header card

Gas Fire Spares - Ceramics

Ceramic products are not suitable for Solid Fuel



14113

GAS EMBER PACK
250g

Moulded Coals Small

14049 (BAG15)

Moulded Coals Large

14050 (BAG10)

Ripped Coals Small

14043 (BAG15)

Ripped Coals Large

14044 (BAG10)

Mini Eurocowl Static Anti-Downdraught Cowl

Designed to cure smoky fireplaces. Prevents down-draughts by creating a positive airflow whatever the wind direction. Fits flue sizes 125mm to 250mm internal diameter. Also prevents birds, vermin and rain entry. Suitable for all fuels. Supplied fully assembled and ready to fit.
Maintenance: High dome allows for effective sweeping in situ. Approvals: BS/EN 1856-1 2009.



14087
Mini Eurocowl Terracotta
Stainless Steel



14089
Mini Eurocowl Natural
Stainless Steel



14090
Mini Eurocowl Black
Stainless Steel

Vermiculite Boards



Board made from Exfoliated Vermiculite and has a high temperature resistance suitable for hotface applications up to 1100°C. The boards are easily cut to size with woodworking tools, the linings contain no ceramic or Asbestos fibres are non-dusting, non-irritant and odourless.

PLAIN
14138
H100 W61 D2.5cm

Vermiculite Fire Bricks

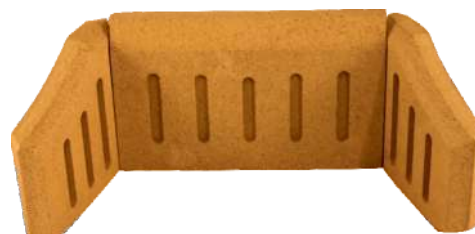

Vermiculite Coal Saver Fire Brick Sets:

All Sides measure W17 H15cm (6.75x6")
Small Back measures W20 H15cm (8x6")
Large Back measures W26 H15cm (10x6")

14163 SMALL - FITS 16" GRATE

14164 LARGE - FITS 18" GRATE

14161 PLAIN 23x11.4x2.5cm (9x4.5x1")

14162 PLAIN 23x11.4x3cm (9x1.5x1.25")

Fire bricks made from vermiculite board.



Vents



14173
Brass Floor Vent

- * 280 x 108mm
- * Hole Size 213 x 76mm
- * Free Area 100 cm² -
- * Rated Input - Max 27kW



14174
Chrome Floor Vent



14159
3 1/4" Core Drill
Wall Vent
Brown Ext Cowl

- * 82mm (3 1/4") Dia
- * 350mm Tube Len
- * Free Area cm² -
- * Rated Input - Max 15kW (
- * Not suitable for gas appliances



14175
3 1/4" Core Drill
Wall Vent
White Ext Cowl



14112
5" Core Drill
Wall Vent

- * Brown External Cowl
- * 127mm (5") Diameter.
- * 350mm (14") Tube Length
- * Free Area cm² - 70 with baffle, 100 without baffle
- * Rated Input - Max 21kW (71,500 Btu/h) with baffle
- * Anti-draught baffle supplied which reduces the 'Effective Free Area'

14178
82mm Direct Ventilation Kit

- * Terracotta External Cowl
- * Kit for stoves with a 75-80mm dia. air supply outlet
- Contains:
- * x1 6x3 Louvre Ventilator, x1 Backplate with a 74.5mm dia. spigot,
- x1 82mm Int dia x 1.5m L Semi Rigid Aluminium Rythose and x2 Jubilee clips

14179
100mm Direct Ventilation Kit

- * Terracotta External Cowl
- * Kit for stoves with a 100mm dia. air supply outlet
- Contains:
- * x1 6x6 Louvre Ventilator, x1 Backplate with a 97mm dia. spigot,
- x1 102mm Int dia x 1.5m L Semi Rigid Aluminium Rythose and x2 Jubilee clips



Stove Thermometers



14024
CALFIRE
Magnetic Stovepipe
Thermometer
Dia.63 (2.5")

Ensure your stove is operating at the correct temperature by using this magnetic thermometer that attaches to your stove pipe.



14025
CALFIRE
Magnetic Stove
Thermometer
Dia.63 (2.5")

Ensure your stove is operating at the correct temperature by using this magnetic thermometer.



14077
CONDAR
Magnetic Stovetop
Thermometer
Dia.63 (2.5")

Ensure your stove is operating at the correct temperature by using this magnetic thermometer that sits on your stovetop.

Carbon Monoxide Detector



14171
10 Year Sleepsafe
Carbon Monoxide Detector

Certified to EN50291-1:2010 - Sealed for life battery - Loud audio alert - 3 LED visual readouts - Test / Silent button - Portable, free standing or mountable.

Digital 3 Colours Moisture Meter



14117
Digital Moisture Meter

Moisture Meter to measure the level in sawn timber and other materials including the environmental temperature. With a wood measurement range of 8 – 60% and an accuracy of +/- 2%, this unit is ideal for checking your wood is well seasoned at the recommended level of around 20%. Red, Amber or green back light to indicate if the wood is dry, has increased or excessive moisture.

Chimney Rods & Brushes



Affordable flexible rods made in Britain using “Superflexy” 12mm diameter rod for added strength and durability. The rods have a high quality brass screw end with 1/2" Whitworth screw fitting featuring chamfered edges to minimise risk of damaging any flexible liners.



Flexible Rod
14135 1 Metre Rod

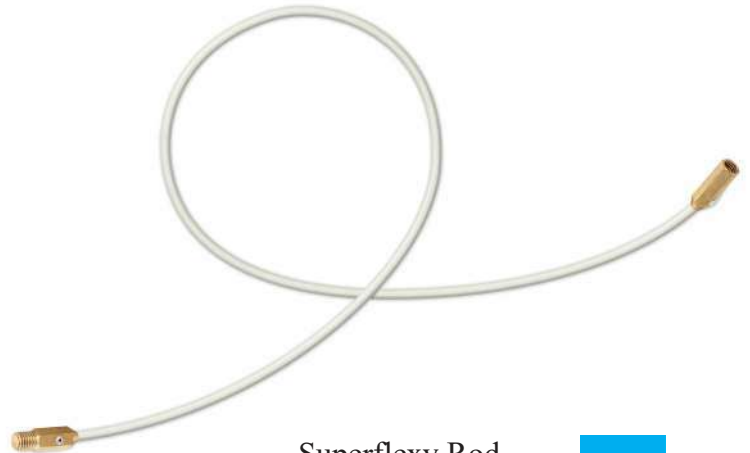

Superflexy Rod
14136 1 Metre Rod
(39")



Soft & Medium bristle brush with protected end boss and Whitworth 1/2" male end screw fitting. Designed for sweeping insulated metal chimneys and flexible flue liners with our flexible rods, where greater flexibility is needed to cope with bends. This can be used with the 1/2 inch to 3/4 inch connector.



Medium Bristle Brush
14131 5"/12.5cm Brush Orange
14132 6"/15cm Brush Orange



Soft Bristle Brush
14133 5"/12.5cm Brush White
14134 6"/15cm Brush White

Brass Rod Adapter
14137
1/2" Whitworth to Universal 3/4"



Strikeable



14170
Pack quantity 24

The 2 in 1 Safety match and Firestarter. Ideal for Stoves, Open fires, BBQ's and Chimineas. Burning time over 10 Minutes, clean to use.

Individual Sachet



14172
Pack quantity 40

Unique in the UK, simple and hygienic to use, just light the wrapper. Suitable for use in smokeless zones for domestic solid fuel appliances, including multi-fuel stoves and bbq's.

Wood Wool



14177
Bag Weight 400g
Approx 32pcs

Wood wool firelighters are produced from natural raw materials. Natural odourless, Burns Co2 neutral, long burn time. Great for wood burners, stoves, BBQ's and camping!

Fire Starter Kit



14158
Fire Starter Kit

The Perfect starter kit for your customer. Kit contains Kiln dried (25cm) logs, Kiln Dried Kindling, Flammers natural firelighters (3 pack) and a handy box of matches.

Box dimensions: 38.4cm x 29cm x 22.5cm high

Flamers



14155 Flamers Pack quantity 24

14156 Flamers Pack quantity 50

14157 Flamers 200 Pack

Flamers firelighters contain natural wood shavings and fully refined paraffin wax. Natural, odourless, easy to light and have a long burn.

Coal Paint

HTP Aerosol 400ml

Rejuvenating or adding a decorative finish to ceramic coals. Fast drying.

04039

Flat Black



Touch Up Paint

HTP 236ml (½ US Pint)

Rejuvenating or adding a decorative finish to ceramic coals. Fast drying.



05101

Flat Black

05102

Satin Black

05103

Metallic Black

Aerosol Can Gun

Firmly snaps onto aerosol to provide greater and more comfortable spray control



04051

Aerosol Can Gun

BBQ Paint

Stove Bright BBQ paint can be used on metal surfaces. Rapid cure, Heat Resistant and resistant to animal and vegetable fats.



04201

Black

HTP Aerosol 400ml

Xylene Thinners

Ideal for use with Stove Bright HT paint. Xylene thinners can be used to clean surfaces down, clean brushes and any other equipment that has been used with oil based paints.



13518

125ml

Gas Vent Pipe Paint

Stove Bright Gas Vent Pipe Paint can be used on Double Wall Flue Pipe to match Vitreous Enamel Finishes. This is a high gloss coating capable of withstanding surface temperatures to 120°C.



04101

Black Ebony

HTP Aerosol 400ml



Colour Charts are available on request

Stove Bright® High Temperature Paint

Stove Bright High Temperature Paint is a high quality, fast drying, high temperature paint for use on wood stoves, pipes, boilers, furnaces, flue pipes, ovens, engines, manifolds, barbecues and cast iron chimineas etc. It can be used on any steel product with extreme surface temperatures up to 650°C and is ideal for touching up ceramic coals. Unique in offering 3 'blacks' and a range of over 30 colours, Stove Bright is used by many of the leading stove manufacturers as their factory finish.

HTP AEROSOL CODES: 400ml

04001	FLAT BLACK	04020	SILVER (ALUMINIUM)
04002	SATIN BLACK	04021	METALLIC MAHOGANY
04003	CHARCOAL	04022	BROWN BARK
04004	METALLIC BLACK	04023	PATRIOT BLUE
04005	METALLIC BROWN	04024	METALLIC RICH BROWN
04006	GOLDENFIRE BROWN	04025	METALLIC RED PRIMER
04007	HONEY GLO BROWN	04026	MEDIUM TEMPERATURE CLEAR
04008	METALLIC MOSS GREEN	04027	COPPER
04009	FORREST GREEN	04028	GREEN ILLUSION
04010	REDWOOD	04029	TERRA COTTA
04011	ALMOND	04030	SHIMMERING ROSE
04012	METALLIC BLUE	04031	SUNSET
04013	METALLIC GREY	04032	SURF SAND
04014	MAUVE	04033	PEWTER
04015	GOLD	04034	EMERALD GREEN
04016	RUSSET	04037	LEATHER BROWN
04017	SAND	04038	NEW BRONZE
04018	MOJAVE RED	04040	LIGHT CHARCOAL
04019	SKY BLUE		

AIRDECO Ecofan

The Caframo AirDeco 8200 series heat-powered fans are designed to circulate the warm air created by a wood-stove.

The 8203 AirDeco generates up to 160 Cubic Feet (of Air) per Minute, and the 8204 AirDeco generates 190 Cubic Feet (of Air) per minute. Both fans can be used as an equivalent to the BelAir Ecofan due to the low starting temperature.

Both fans are sold with a 4 Year Warranty.



E8203BB
AirDeco Ecofan
W11 D6.6 H22.3cm
(4.3x2.6x8.75")
Min Stove Temp 65°C

E8204BB
AirDeco Ecofan
W11 x D7.6 x H23.9cm
(4.3x3x9.4")
Min Stove Temp 70°C



It is important to read and follow the instructions on the correct placement of the Ecofan to ensure satisfactory long term use and that your stove is working within the temperature range of 'best operation'. We recommend the use of our Stovetop Thermometers; see page 15 for details.

Spare Parts for Ecofans

Replacement Motor Kits are available for the Ecofans as detailed below. Unfortunately, we are unable to offer thermo-electric modules for sale as their replacement is a controlled process involving strict torque settings. If you believe the module has failed you are welcome to send your Ecofan to CALFIRE who will quote you accordingly. Please note that we will only sell Ecofan spare parts for use on original Ecofans; not for any other purpose.

Motor Replacement Kits

After much usage, an Ecofan motor can wear out. Motor Replacement Kits are available for customers who wish to install a new motor rather than sending the old unit back to CALFIRE for repair, or purchasing a new Ecofan. The replacement task is straight forward; however on some older models the consumer must have the capability to solder the new motor to the existing wires. The replacement kit comprises a new motor, an Allen/hex key to remove the blade and full instructions.

* To see how easy it is to change the motor on the 810 or 812 Ecofans view the video online at www.ecofan.co.uk/videos.html or scan the QR code below with your smart-phone or tablet.



ES006



ES009



ES017

ES006 800 Original, 802 AirPlus or 806GS (Soldering & Push-On Type), 815 Original Mini

ES009 810 UltraAir, 812 AirMax, 8200 AirDeco range (Push-On Type Only)

ES017 806 BelAir (2014 Model - Push-On Type Only)



Ecofan ^{BelAir}



The Caframo BelAir Ecofan 806 is a heat-powered fan designed to circulate the warm air created by many low temperature gas, pellet or contemporary stoves operating with normal surface temperatures of between 75°C and 200°C. The BelAir Ecofan generates up to 140 Cubic Feet (of Air) per Minute. (At 75°C it will move 50 CFM). The BelAir Ecofan must not be used on a wood-stove or where the surface temperature exceeds 200°C .

Dims: Base Plate W16.2 D6.1cm (6.4x2.4"). H24.1cm (9.5") from base to top of blade. Blade diameter 23.2cm (9")

E806BB

Ecofan ^{AIRMAXDUO}



The Caframo AirMax DUO Ecofan 814 is a heat-powered fan designed to circulate the warm air created by a wood-stove operating with normal surface temperatures of between 75°C and 345°C. The DUO is the first fan proven to deliver over 200 CFM! (At 75°C it will move 50 CFM).

Dual modules make the AirMax DUO the highest performing Ecofan to date. Optimized power transfer, quicker start time and an updated blade contour for increased airflow.

Dims: Base Plate W12.7 D9.1cm (5x3.5"). H235cm (9.25") from base to top of blade. Blade diameter 23.2cm (9")

E814BB



5 YEAR WARRANTY

Ecofan ^{AIRMAX}



The Caframo AirMax Ecofan 812 is a heat-powered fan designed to circulate the warm air created by a wood-stove operating with normal surface temperatures of between 85°C and 345°C. The AirMax Ecofan 812 generates up to 175 Cubic Feet (of Air) per Minute. (At 85°C the AirMax Ecofan 812 will move 50 CFM)

Dims: Base Plate W121 D82 (4.75x3.25"). H248 (9.75") from base to top of casting, excluding handle. Blade diameter 232mm (9")

E812BB

Ecofan ^{ULTRAIR}



The Caframo UltrAir Ecofan 810 is a heat-powered fan designed to circulate the warm air created by a wood-stove operating with normal surface temperatures of between 100°C and 345°C. The Ultrair 810 Ecofan generates up to 125 Cubic Feet (of Air) per Minute. (At 100°C the UltrAir Ecofan 810 will move 50 CFM)

Dims: Base Plate W12.1 D7.6cm (4.75x3"). H22.2cm (8.75") from base to top of casting, excluding handle. Blade diameter 20.6cm (8")

E810BB

Ecofan ^{ORIGINAL}



The Caframo Original Ecofan 800 is a heat-powered fan designed to circulate the warm air created by a wood-stove operating with normal surface temperatures of between 110°C and 345°C. The Original Ecofan 800 generates up to 100 Cubic Feet (of Air) per Minute. (At 110°C the Original Ecofan 800 will move 50 CFM)

Dims: Base Plate W10 D7.5cm (4x3"). H23.5cm (9.25") from base to top of blade, excluding handle. Blade diameter 20.5cm (8")

E800BB

Ecofan ^{ORIGINAL MINI}

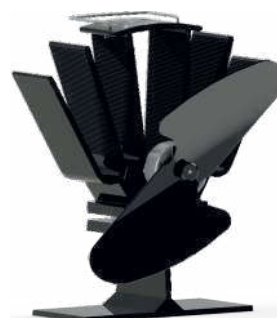

The Caframo Original Mini Ecofan 815 is a heat-powered fan designed to circulate the warm air created by a wood-stove operating with normal surface temperatures of between 110°C and 345°C. The Original 815 Mini Ecofan generates up to 85* Cubic Feet (of Air) per Minute. (At 115°C* the Original Mini Ecofan 815 will move 50 CFM)

Dims: Base Plate W10 D7.5cm (4x3"). H16.5cm (6.5") from base to top of blade, excluding handle. Blade diameter 16cm (6.3")

E815BB

Ecofans - UK website www.ecofans.co.uk

The Caframo Ecofan is a heat-powered fan designed to circulate the warm air created by a wood or gas stove. Improved warm air circulation results in greater comfort and less fuel consumption.

Why buy a Stove Fan?

- * **Costs nothing to run...** Using the heat from the stove, a Stove Fan is the most economical way to effectively circulate the warm air your stove produces. No cables, plugs or batteries are required.
- * **Cuts your fuel bills...**
- * **Increased Efficiency...** warm air is pushed out into the living area rather than just rising to the ceiling above the stove. This improves the heating effectiveness of the stove and results in greater room comfort as shown below.

* Heat distribution without a Caframo Ecofan

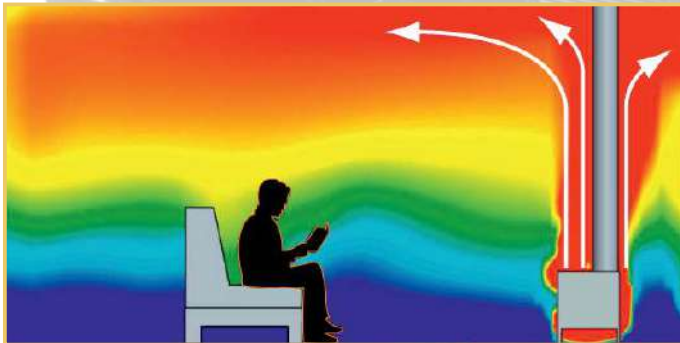

* Simulation

* Heat distribution with a Caframo Ecofan

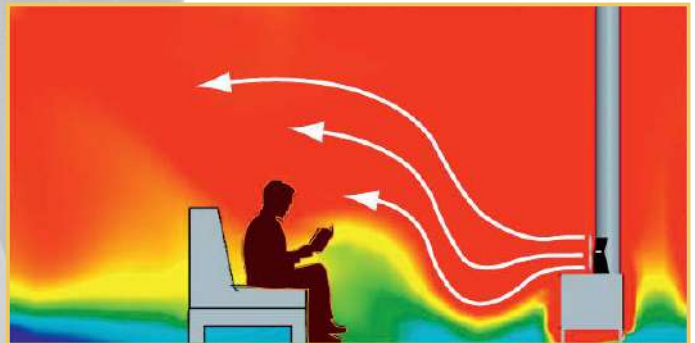

* Simulation

Reasons to buy a Genuine Caframo Ecofan

- * Caframo have two decades of experience perfecting the Ecofan. **This means lower failures and higher customer satisfaction.**
- * Caframo Ecofans are made in Canada, last longer and utilise a superior design that operates more efficiently and effectively than 3, 4 or 5 blade models.
- * More Caframo Ecofans have been sold than all other stove top fans combined.
- * Test results using AMCA testing standards prove that most air flow claims made by other stove top fan manufacturers are exaggerated, some by as much as 45%.
- * **Fully CE compliant for Immunity Emissions and Product Safety**
- * **All Caframo Ecofans are sold with a 2 or 4 year warranty.**



Caframo Ecofans are assembled in CANADA with domestic and imported parts



Caframo Ecofans fully comply with all CE Immunity Emissions and Product Safety requirements.

How to get the most from your Ecofan

Placement of your Ecofan on your stove top is critical. Be sure to position the Ecofan on the stove so that cool air will be drawn over the 'cooling fins'. The Ecofan should not be used directly in front of the stovepipe or at the front of the stove. Place the Ecofan at the back edge of the stove as shown in the diagram. Should the gap between the rear of your stove and your wall be less than 150mm (6") then move your Ecofan forward, along the side of your stove and turn it in slightly. This should ensure your fan can draw the necessary cooler air from the rear/side of your stove.





Grey

23144

Match Box Holder
H15xW9xD5cm
(6x3.5x2")

23139

Large Kindling Bucket
Dia 30cm
(12")

23146

Fire Lighter Holder
H20xW13.5xD9cm
(8x4x3.5")

23140

Large Ash Bucket
Dia 30cm
(12")

23138

Small Kindling Bucket
Dia 23cm
(9")

23149

Match Holder Inc Matches
Height: 11"
with matches



Antique Pewter

23145

Match Box Holder
H15xW9xD5cm
(6x3.5x2")

23142

Large Kindling Bucket
Dia 30cm
(12")

23147

Fire Lighter Holder
H20xW13.5xD9cm
(8x4x3.5")

23143

Large Ash Bucket
Dia 30cm
(12")

23141

Small Kindling Bucket
Dia 23cm
(9")

23150

Match Holder Inc Matches
Height: 11"
with matches



Ivory

29090

Match Box Holder
H15xW9xD5cm
(6x3.5x2")

23116

Large Kindling Bucket
Dia 30cm
(12")

29092

Fire Lighter Holder
H20xW13.5xD9cm
(8x4x3.5")

23117

Large Ash Bucket
Dia 30cm
(12")

23133

Small Kindling Bucket
Dia 23cm
(9")

23148

Match Holder Inc Matches
Height: 11"
with matches



Black

29091

Match Box Holder
H15xW9xD5cm
(6x3.5x2")

23118

Large Kindling Bucket
Dia 30cm
(12")

29093

Fire Lighter Holder
H20xW13.5xD9cm
(8x4x3.5")

23119

Large Ash Bucket
Dia 30cm
(12")

23134

Small Kindling Bucket
Dia 23cm
(9")

29055

Match Holder Inc Matches
Height: 11"
with matches

Specified finishes
relate to colour only
and not material.

Coal Buckets

Dryton Hod



23014
Black
H53.5cm (21")
Dia. 22.5cm (9")



23033
Zinc
H53.5 Dia 22.5cm
(21x9")



23080
Antique
H53.5 Dia 22.5cm
(21x9")

Dorset Hod



23164
Black/Nickel
H 46 Dia 23.5cm
(18x9.25")

Cumbria Hod



23182
Black
Wood Handles
H 54 Dia 24cm
(21.25x9.5")

Norfolk Hod



23072
Black
H 58 Dia 22.5cm
(23x9")



23073
Black & Brass
H 58cm Dia.22.5
(23x9")

Somerset



23158
Black
H 38.5 Dia 28cm
(15x11")

Wessex



23159
Black/Nickel
H 28.5 Dia 23.5cm
(11x9.25")

Devon



23160
Black
H 29.5 Dia 28cm
(11.5x11")

Surrey



23161
Black
H 33 Dia 26cm
(13x10")

Hereford



23162
Black/Nickel
H 39 Dia 28cm
(15x11")

Wiltshire



23181
Black
H 42 Dia 23cm
(16.5x9")

Specified finishes
relate to colour only
and not material.

Coal Buckets

Plealey



23050
All Black
Dia. 25.5cm (10")

Kenley (Medium) Dia. 27cm (10.5")



23015M
All Black

Lancs



23188
Galvanised
H 36 Dia 25cm
(14x10")

NEW

Suffolk



23163
Black
H 22 Dia 19.5cm
(8.5x7.5")

Kenley (Set of 2) All Black



23015/2
Dia. 27-33cm (10.5-13")

Kindling

Astley



23016
Black
W38 D20.5cm
(15x8")

CW Kindling Basket

Will hold just over half of the retail sales pack of the shorter popular kindling



23101
H13 W30.5 D20cm
(5x12x8")
Excludes handles

Ring



Suitable for all kindling

23090
Black
H23 W21.5 D21.5cm
(9x8.5x8.5")

Round Kindling Basket

Suitable for all kindling



23122
H33 Dia.38cm
(13x15")

CW Kindling Holder



Will hold just under half of the retail sales pack of the shorter popular kindling

23095
Black
H18 W22cm
(7x8.75")

Marton



Suitable for kindling of around 250mm long

23091
Black
H24 W21.5cm
(9.5x8.5")



23136
Set2 Vertical Weave Log Baskets
Full Buff Willow with
rope handles and hessian lining
Large Basket H43.5 Dia.50cm
(17x20")
Small Basket H38 Dia.42cm
(15x16.5")

23100
Set3 Round Willow Log Baskets
Full double steamed buff &
green willow with rope handles
Large Basket H28cm Dia.49.5cm
(19.5x11")



23178
Deluxe Four Tone Rope
Handled Log Basket
Height 46cm Dia.45cm
(18x17.5")

23124
Set2 Country Buff Willow Log Baskets
Full double steamed buff and
rustic willow with lining
Large Basket H40 Dia.50cm
(16x20")
Small Basket H30 Dia.39cm
(12x15")



23183
Mellowed Willow Lined
Log Basket
Height 38 Dia.51cm
(15x20")

23171/2
Set2 Deluxe Rope handled
Provence. Full buff willow
with rope handles and white wash.
Medium Basket H42 Dia.51cm
(16.5x20")
Small Basket H33 Dia.40cm
(13x15.75")





23102
Round Rustic Log Basket
Full rustic and buff with integral handles
Height 39 Dia.48cm (15.5x19")



23137
Liner Only for 23102 Log Basket
Elasticated white liner made for the 23102 basket but suitable for many round baskets with a similar diameter and integral handles.



23083
Height 38 Dia.51cm (15x20")

Wild Willow Log Basket
Full wild willow with external handles and hessian lining



23172
Height 30 Dia.43cm (12x17")



23123
Buff Willow Log Basket
Full double steamed buff willow with stripe
Height 37 Dia.51cm (15x20")



23125
Set2 Provence Tall Round Willow Log Baskets
Full buff willow with wash finish and lining
Large Basket H57 Dia.55cm (20x22")



23096
Buff Willow Tall Log Basket with Lining
Full double steamed buff willow with rustic stripe and hessian lining.
Height 56 Dia.51cm (22x20")



23135

Set3 Rope Handled Log Baskets
Full wild willow with rope handles and hessian lining
Large Basket H40 W64 D47cm (16x25x18.5")



Set3 Harvest Basket full wild willow.

23175L Large Basket H31 W83 D48cm (12x32.5x19")
23175M Medium Basket H26 W70 D35cm (10x27.5x13.75")
23175S Small Basket H22 W62 D29cm (8.5x24.5x11.5")



23173

Large Set2 Log Basket - Double steamed
full buff and green with willow ear handles.
Large Basket H49 W68 D45cm (19x26.75x17.5")
Medium Basket H43 W60 D40cm (17x23.5x15.75")



23174/2

Set2 Rectangular Double steamed full buff
and rustic willow with integral handles
Medium Basket H39 W58 D47cm (15x23x18.5")
Small Basket H36 W48 D39cm (14x19x15")



23099

Set3 Full Green, double steamed buff
and white willow with integral handles.
Large H39 W61.5 D46cm (15.5x24x18")



23126

Set2 Mellowed full buff willow
vertical weave with rope handles.
Large H50 W56 D37cm (20x22x14.5")
Small H48 W49 D30cm (19x19x12")

Stockholm



23120

Set 2 Log & Kindling Holders
 Log: H29.5 Dia33cm (11.5x13")
 Kindling: H22 Dia20cm (8.5x8")
Logs not supplied

Gothenburg



23151

Set of 3 Log/Kindling & Match Holder Black
 Logs - Dia32 H29cm (12.5x11.5")
 Kindling - Dia23 H20.5cm (9x8")
 Matches - Dia7 H20.5cm (2.75x8")

Copenhagen



23179

Set of 3 Log/Kindling & Match Holder Pewter
 Logs - Dia32 H29cm (12.5x11.5")
 Kindling - Dia23 H20.5cm (9x8")
 Matches - Dia7 H20.5cm (2.75x8")

Nordby



23180

Set of 3 Log/Kindling & Match Holder Copper
 Logs - Dia32 H29cm (12.5x11.5")
 Kindling - Dia23 H20.5cm (9x8")
 Matches - Dia7 H20.5cm (2.75x8")

Kiruna



23184

NEW

Set of 3 Log/Kindling & Match Holder Galvanised
 Logs - Dia33 H29cm (12.5x11.5")
 Kindling - Dia23 H20.5cm (9x8")
 Matches - Dia7 H20.5cm (2.75x8")
 (Matches Included)

Arvika



23186

NEW

Set of 3 Log/Kindling & Match Holder Ant/Brass
 Logs - Dia33 H29cm (12.5x11.5")
 Kindling - Dia23 H20.5cm (9x8")
 Matches - Dia7 H20.5cm (2.75x8")
 (Matches Included)

Kindling Cut Out Buckets



23185

NEW

Galvanised
 H29 Dia 22cm
 (11.5x8.5")



23187

NEW

Ant/Brass
 H29 Dia 22cm
 (11.5x8.5")

Montana



23152

Copper Log Carrier
 H30 W52 D30cm
 (12x20.5x12")

Fire Wood Cut Out Buckets



23165

Set of 2 Oval Fire wood cutout Buckets with
 Golden Shade

Large - H32 W50 D28cm (12.5x19.5x11")
 Small - H23 W45 D25cm (9x17.5x10")

Life Tree Emboss Buckets



23155L Large - H35 W45 D45cm (13.75x17.75x17.5")

23155S Small - H31 W35 D35cm (12x13.75x13.75")

Fire wood Emboss Buckets



23154L Large - H35 W45 D45cm (13.75x17.75x17.5")

23154S Small - H31 W35 D35cm (12x13.75x13.75")

Cross Emboss Buckets



23166L Large - H38 W53 D40cm (15x21x15.75")

23166S Small - H34 W41 D32cm (13.5x16x12.5")

Round Emboss Buckets



23169L Large - H35 W45 D45cm (13.75x17.5x17.5")

23169S Small - H31 W35 D35cm (12x13.75x13.75")

Hammer Logs/Fire Wood Cut Out Buckets



23167L Large - H35 W45 D45cm (13.75x17.5x17.5")

23167S Small - H31 W35 D35cm (12x13.75x13.75")

Hammer Logs/Fire Wood Emboss Buckets



23168L Large - H35 W45 D45cm (13.75x17.5x17.5")

23168S Small - H31 W35 D35cm (12x13.75x13.75")

Lipley



23130

Black H60.5 W41 D22cm (24x16x8.75")
Made for standard UK length logs

Roden



23062

- Black H26.5 W51 D29cm
(10x20x11")

Log Carriers & Racks

Cheshire



23176

Black H84 W68 D23cm (33x26.75x9")

Felton



Logs not supplied.

23065

Black H61.5 W40 D30cm (24x16x12")

Modern Mesh



23127

Black Log Carrier with
metal handles
H31 Bdia26.5 Udia32cm
(12x10.5x12.5")

NEW

Lincoln



Logs not supplied.

23157

Black Log Carrier
H75 W30 D40cm
(30x12x15.75")

Items 23176 & 23065 are supplied flat packed and requires assembly.

Forged



Made for standard UK length logs

23128
Black
H42 W45.5 D20.5cm
(16.5x18x8")

Matching fireset
27147 available;
see page 44



23129
Antique Pewter
H42 W45.5 D20.5cm
(16.5x18x8")

Matching fireset
27148 available;
see page 44

Log Splitter



29095
H36 Base Dia 27.5 Upper Dia 24cms

Split your own logs with the stand alone Log splitter. This can also be screwed down for more stability and safety.

Sling Carrier



23112
Black
H40.5 W71 D24cm
(16x28x9.5")

Match Holder



29072 **NEW**
Galvanised
Holder Height H20cm (8")
(Matches not included)



29077
Satin & Polished Steel
Holder Height H20cm (8")
(Matches Included)



29075 **NEW**
Ant/Brass
Holder Height H20cm (8")
(Matches not included)

Long Matches



29005
L28cm (11")
90 matches per box
16 Boxes per case

Coal Logs & Tongs



29060 - Solid Brass Coal Tongs
Size L26.5cm (10")



29062 - Black Coal Tongs
Size L26.5cm (10")



29063 Black Log Tongs
Size L39cm (15")



29008 - Black Cast Coal Tongs
Size L35cm (14")



29059 - British Coal Tongs
Size L33cm (13")



Brush Refills



29070 - 5cm Ø
Round Brush (Chinese)

29046 - 4.6cm Ø
Round Brush (Indian)

29056 - 4cm Ø
Small Round Brush
(Indian 16"
Companion Sets)



29009
Oblong Brush
10x2.8cm



29079
Straw
Brush
(Chinese)

Shovels



- A. **28040** 6" Steel Shovel
- B. **28039** 5" Steel Shovel
- C. **28038** 4" Steel Shovel



- 28044**
10x8" Galv Shovel



- D. **28042** 9x7" Shovel
- E. **28043** 10x8" Shovel



- 29097**
L41 W20 D 11.5cm
(16x8x4.5")
Shovel & Brush Set
Black with mango wood
handles

Individual Tools

Hangers

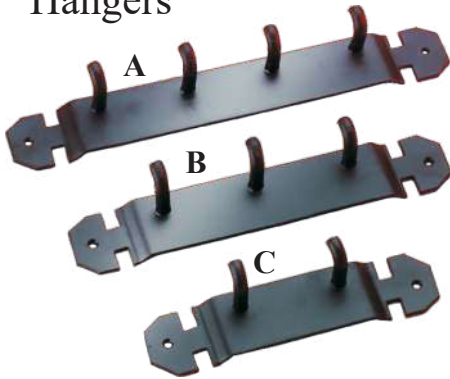

- | | | |
|----------------------------|-------------------------|-------------------------|
| A | B | C |
| 29054 | 29053 | 29052 |
| 4 Position
L26.5cm(10") | 3 Position
L22cm(9") | 2 Position
L16cm(6") |

Ring Top Tools - Length 45cm (18")



Toasting Fork recommended only for Ornamental use.

- | | | | | | |
|---------------|--------------|--------------|--------------|--------------|--------------|
| 29083 | 29084 | 29085 | 29086 | 29087 | 29088 |
| Toasting Fork | Coal Tongs | Shovel | Brush | Log Roller | Poker |

Loop Top Tools - Length 45cm (18")



Toasting Fork and Roaster recommended only for Ornamental use.

- | | | | | | | | | |
|---------------|--------------|--------------|--------------|--------------|--------------|--------------|--------------|--------------|
| 29030 | 29031 | 29032 | 29033 | 29034 | 29035 | 29036 | 29037 | 29089 |
| Toasting Fork | Coal Tongs | Log Tongs | Shovel | Brush | Log Roller | Poker | Roaster | Ash Scraper |

Rope Twist Tools - Length 45cm (18")



Toasting Fork and Roaster recommended only for Ornamental use.

- | | | | | | | | |
|---------------|--------------|--------------|--------------|--------------|--------------|--------------|--------------|
| 29038 | 29039 | 29040 | 29041 | 29042 | 29043 | 29044 | 29045 |
| Toasting Fork | Coal Tongs | Log Tongs | Shovel | Brush | Log Roller | Poker | Roaster |

Pokers & Poker Sets



29021
Black Poker & Stand
H 58cm (23")



29067
Poker & Ash Scraper Set. L61cm (24"); Black



29073
Brass Poker
L 56cm (22")



29074
Chrome Poker
L 56cm (22")



29078
Black Poker
L 56cm (22")



29065
Black Victorian Poker
L 70cm (28")



29061
British Poker
L 50cm (19.5")



29068
British Half Moon
Ash Scraper
L 50cm (19.5")



29076
Sets of 5 various Pokers. L76cm (30")

Hearth Tidies & Bellows



29003
Black Cast
L 30cm (12")



29064
Black &
Brass Cast
L 30cm (12")



29081
Black &
Pewter Cast
L 30cm (12")



29019
Black Large Ball
L 34cm (13")



29098
Galvanised
Mortimer
L 32cm (12.5")

NEW



29049
Black Hook
L 33cm (13")



29066
Black Traditional
L 38cm (15")

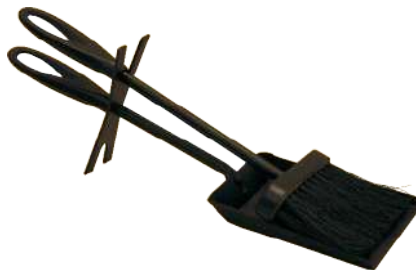

29071
Black Loop
L 38cm (15")



29082
Black & Pewter Loop
L 38cm (15")



29094
Black Hanging
H 43cm (17")



29096
Black Wall Hanging Loop
L 40cm (15.75")



29080
Plain Hardwood Bellows
Length 35.5cm (14")



29069
Carved Hardwood Bellows
Length 47cm (18.5")



Ornamental use only

29016
Wood
Length 42cm (16")



29015
Fleur-de-lys Hardwood Bellows
Length 47cm (18.5")

Made from Sheesham Wood, Leather & Solid Brass. Sheesham is a heavy hardwood with a rich chestnut colour. The Bellows are also made using recycled wood and may have slight blemishes and marks.

Companion Sets

Hordley



27130 ■
All Black
H 60.5cm (24")



27131 ■
All Pewter
H 60.5cm (24")

Pyramid



27132 ■
All Black
H 66cm (26")



27133 ■
All Pewter
H 66cm (26")

Eclipse



27150 ■
All Black
H 53cm (21")



27151 ■
Black & Pewter
H 53cm (21")

Large Loop



27153 ■
All Black
H 61cm (24")



27154 ■
Black & Pewter
H 61cm (24")

Fleur-de-lys



27105 ■
All Black
H 52cm (20.5")



27106 ■
Brushed Steel
H 52cm (20.5")

Forged



27147 ■
All Black
H 48.5cm (19")



27148 ■
Antique Pewter
H 48.5cm (19")

Modern Round



27092 ■
All Black
H 58cm (23")

Petton



27137 ■
All Black
H 60.5cm (24")

Ercall



27097 ■
All Black
H 61cm (24")

Tilley



27135 ■
All Black
H 66.5cm (26")

Rope Twist



Supplied with Log & Coal Tongs with Poker in centre.

27041 ■
All Black
H 65cm (26")

Traditional Top



27108 ■
All Black
Round Base
H 57cm (22.5")

Traditional Top



27088 ■
All Black
3 Legged Base
H 60cm (24")

Shepherds Crook



27144 ■
All Black
H 71cm (28")

Knight



27120 ■
Silver Black
H 74cm (29")

Stamford



27152 ■
Copper Antique
H 54cm (21")

Craftsman



27140 ■
All Black
H 76cm (30")

Modern Ball



27064 ■
All Black
H 46.5cm (18")

Basket



27057 ■
All Black
H 41cm (16")

Regency



27078 ■
All Black
H 47cm (18")

Duchess



27043 H40cm (16") ■
27045 H48cm (19") ■
All Black

Burlton



27149 ■
All Black
H 51cm (20")

Cast



27018 ■
All Black
H 52cm (20.5")

Wood Stove



27142 ■
All Black
H 53.5cm (21")

Loop



27006
All Antique
H 63cm (25")



27008
Black & Chrome
H 63cm (25")



27013
Black & Brass
H 63cm (25")



27023
All Black
H 63cm (25")



27101
Black & Pewter
H 63cm (25")



27127
All Pewter
H 63cm (25")

Mortimer



27156
Galvanised
H 60cm (23.5")

NEW



27157
Ant/Brass
H 60cm (23.5")

NEW

Gallery



27019
All Black
H 59cm (23")

Traditional Top - Round Base



27115
Black & Pewter
H 40.6cm (16")



27116
Black & Antique
H 40.6cm (16")



27095
All Black
H 40.6cm (16")

Companion Sets

Acorn



27017 ■
All Black
H 54cm (21")



27117 ■
Black & Pewter
H 54cm (21")



27030 ■
Black & Antique
H 54cm (21")

Pony



27125 ■
All Black
H 52cm (21")

Rushton



27054 ■
All Black
H 63.5cm (25")

Cage



27104 ■
All Black
Height 68.5cm (27")

Woodman



27155 ■
All Black
Height 61cm (24")

Ball Top



27112 ■
Black & Pewter
H 59cm (23")



27128 ■
All Pewter
H59cm (23")



27113 ■
Black & Antique
H 59cm (23")



27094 ■
All Black
H59cm (23")

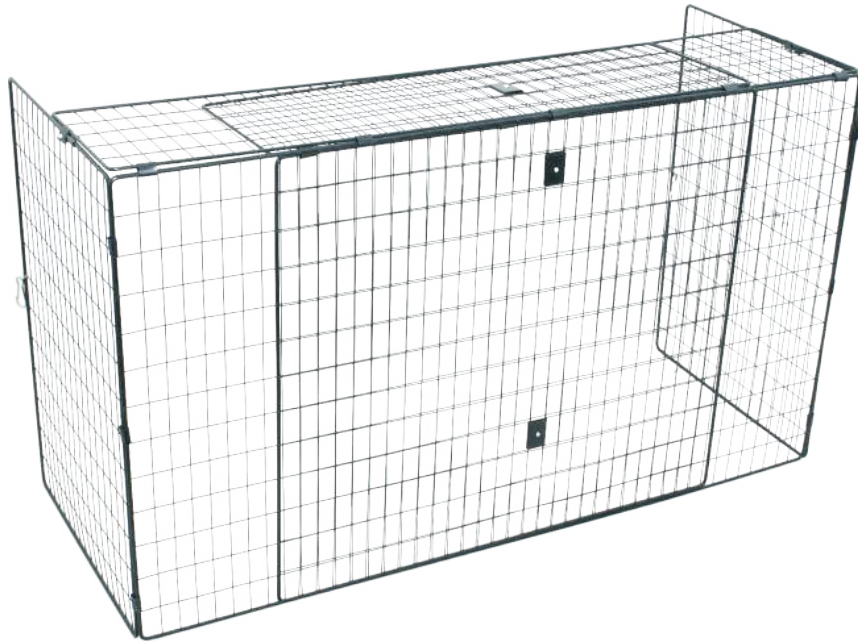

Extending Nursery

20053
Extending Nursery Guard
H67 W90/152.5 D45.5cm
(26x36/60x18")

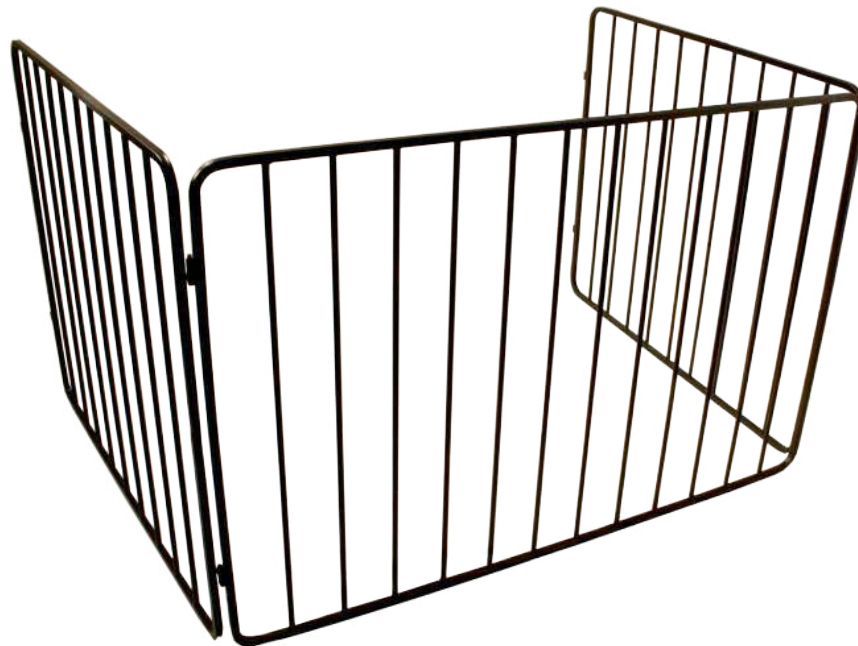

Stove Nursery

21085
Stove Nursery Guard
H75 W112 D86.5cm
(29.5x44x34")



The Stove Nursery Guard is supplied with only one fixing kit.

Each kit will only connect the guard in one place on each side.

75mm Between Bars

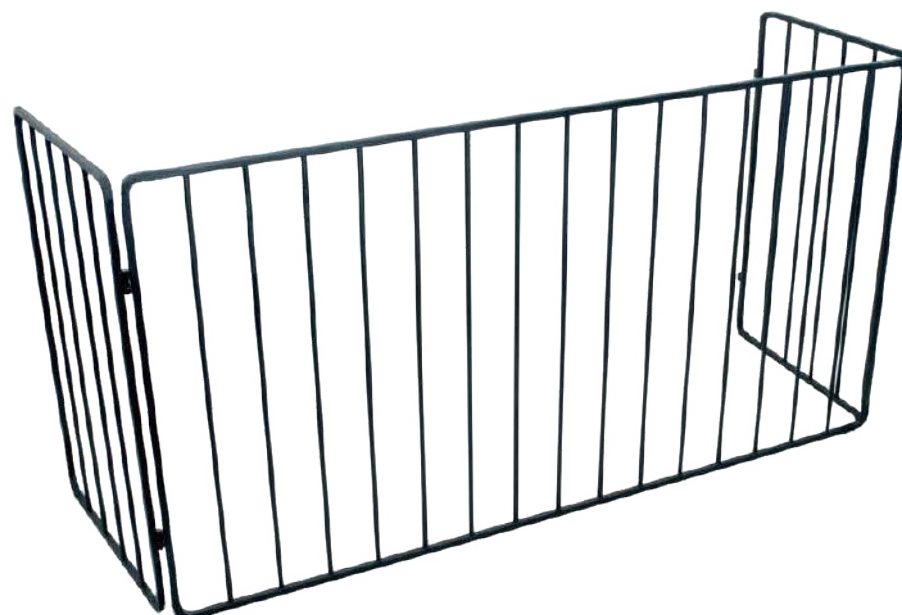

Bar Nursery

21086
Bar Nursery
H75 W140 D48cm
(29.5x55x19")



The Stove Nursery Guard is supplied with only one fixing kit.

Each kit will only connect the guard in one place on each side.

75 mm Between Bars

Fireguards

Dynasty 3 Fold
Black



21030 ■
H68 W43 Wings 21cm
(26.75x17x8")

21025 ■
H72 W61 Wings 28cm
(28.25x24x11")

Dynasty 3 Fold
Antique



21024 ■
H68 W43 Wings 21cm
(26.75x17x8")

21021 ■
H72 W61 Wings 28cm
(28.25x24x11")

Dynasty 3 Fold
Pewter



21048 ■
H68 W43 Wings 21cm
(26.75x17x8")

21078 ■
H72 W61 Wings 28cm
(28.25x24x11")

Dynasty 3 Fold
Brass



21015 ■
H68 W43 Wings 21cm
(26.75x17x8")

21010 ■
H72 W61 Wings 28cm
(28.25x24x11")

3 Fold Rectangle

21111 ■ **NEW**
Galvanised
H65 W41 Wings 20cm
(25.5x16x8")



21112 ■ **NEW**
Ant/Brass
H65 W41 Wings 20cm
(25.5x16x8")

Dynasty 4 Fold
Brass



21011 ■
H82 Panels 31.5cm (32x12")

Dynasty 4 Fold
Black

21027 ■
H54 Panels 20cm (21x8")

21028 ■
H64 Panels 20cm (25x8")

21029 ■
H71 Panels 31.5cm (28x12")

21026 ■
H82 Panels 31.5cm (32x12")



Arched

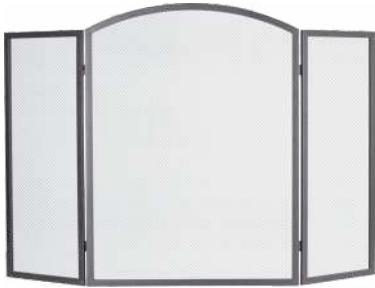

21099 ■

Black

H71 W61 Wings 28cm (28x24x11")

Basic



21096 ■

Black

H63.5 W53 Wings 23cm (25x21x9")

21097 ■

Black

H73.5 W61 Wings 30cm (29x24x11.75")

Wave



21106 ■

Black

H58 W48 Wings 21cm (22.75x19x8.25")

Curved



21107 ■

Black

H60 W60 D15cm (23.5x23.5x6")

3 Fold Square

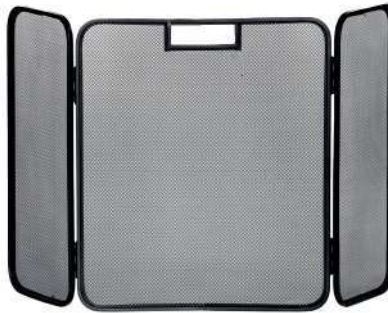

21108 ■

Black

H71 W51 Wings 25cm (28x20x10")

Fan Guard



21109 ■

Black

H61 W76 D 13cm (24x30x5")

3 Fold Curved

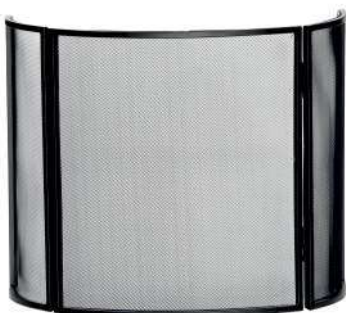

21110 ■

Black

H60 W52 Wings 26cm (23.5x20.5x10")

Spark Guard



21069 ■

Black

H63 W52 D9.5cm (25x20.5x4")

21070 ■

Black

H66.5 W66.5 D9.5cm (26x26x4")

Domed Guard



20051 ■

Black

H60 W55.5 D22cm (23.5x22x8.5")

20054 ■

Black

H53 W48.5 D20cm (21x19x8")



Flat



Black

- 20055** H61 W61cm (24x24")
- 20079** H61 W76cm (24x30")
- 20080** H68.5 W76cm (27x30")
- 20081** H76 W91.5cm (30x36")

Not suitable for fixing kit

Box Closed



20018

Black
H61 W64 D23cm
(24x25x9")

20109

Black
H76 W76 D25cm
(30x30x10")

Arched Flat



Black

- 20011** H61 W61cm (24x24")
- 20082** H61 W76cm (24x30")
- 20083** H68.5 W76cm (27x30")
- 20084** H76 W91.5cm (30x36")

Not suitable for fixing kit

Wedge



20016

Black
H61 W58.5 D15cm
(24x23x6")

Fixing kit 21500 available separately; see page 57 for details.

Curved



20015

Black
H61 W58.5 D7.5cm
(24x23x3")

Not suitable for fixing kit

Box Open



20017

Black
H61 W64 D23cm
(24x25x9")

All Classic firescreens can be made to your specific requirements please allow 10mm tolerance

All Firescreen frames made with a 10mm mild steel square bar Heights given for firescreens exclude handles.





Classic Firescreens

Winged



Black

20085
H58.5 W45.5 D20cm
(23x18x8")

20086
H68.5 W76 D20cm
(27x30x8")

20020
H61 W61 D20cm
(24x24x8")

20087
H76 W91.5 D20cm
(30x36x8")

Sloping Box



20061
Black
H69 W61 D20.5cm
(27X24X8")

Bent Open



Black

20088
H56 W63.5 D15.5cm
(22x25x6")

20089
H76 W76 D15.5cm
(30x30x6")

20013
H61 W66 D15.5cm
(24x26x6")

3 Fold Arched



Black

20097
H61 W61 D18cm
(24x24x7")

20098
H69 W76 D18cm
(27x30x7")

20099
H76 W91 D18cm
(30x36x7")

Arched Bent



20074
Black
H66 W66 D13cm
(26x26x5")

Flat Sided Bowed



20068
Black
H61 W79.5 D18.5cm
(24x31x7.25")

Not suitable for fixing kit

All Classic firescreens can be made to your specific requirements please allow 10mm tolerance

All Firescreen frames made with a 10mm mild steel square bar Heights given for firescreens exclude handles.





Double Rail Box Open



20092
Black
H65 W66 D17.5cm
(25.5x26x7")

20093
Steel Lacquer Finish
H65 W66 D17.5cm
(25.5x26x7")

Bent Box



20090
H56 W63.5 D15.5cm
(22x25x6")

20091
H76 W76 D15.5cm
(30x30x6")

20078
H61 W66 D15.5cm (24x26x6")



Bowed Front

20075
All Steel
H60.5 W61 D22.5cm
(24x24x9")

20058
Black
H60.5 W61 D22.5cm
(24x24x9")

20096
Black
H77 W77 D22.5cm
(30x30x9")

Double Rail Fender Guard



20095
Steel Lacquer Finish
H20 W61 D15cm
(8x24x6")



20094
Black
H20 W61 D15cm
(8x24x6")

Arched Box



20067
Black
H71.5 W58.5 D15.5cm
(28x23x6")

Gothic Arch



20103
Black
H66 W65 D14cm
(26x25.5x5.5")

All Classic firescreens can be made to your specific requirements please allow 10mm tolerance

All Firescreen frames made with a 10mm mild steel square bar
Heights given for firescreens exclude handles.





Classic Firescreens

Flat Fan



20069
Black
H62 W77cm
(24.5x30")

Not suitable for fixing kit

Crescent



20076
Black
H60 W77 D17.5cm
(23.5x30x7")

Noble Screen Fixing Kit



Kit comprises:
2 brackets (left and right hand),
2 fixing bolts & nuts,
2 wall brackets with adhesive pads,
2 wall brackets for drilling,
4 fixing screws & wall plugs.

Suitable for Noble Screens as shown

21500

Heavy Stove Guard

Please note with this guard the depth cannot be greater than the width on any made to measure specials.



Black **20073** H61 W76 D62.5cm (24x30x24.5") 10mm Between Bars

Fixing kit 21500 available separately;

All Classic firescreens can be made to your specific requirements
please allow 10mm tolerance

All Firescreen frames made with a 10mm mild steel square bar
Heights given for firescreens exclude handles.



Traditional Fire Backs - up to W61cm (24")

The thickness of our firebacks vary from ½" to 2" according to size. All firebacks are painted black.

To install, simply lean the fireback against the rear of the fireplace. Some firebacks are still hand moulded and cast in much the same way as they have been for generations. Apart from the aesthetic value, firebacks prevent scorching of the rear brickwork and help to radiate heat - a point worth remembering when installing a gas log or coal effect fire as they are equally effective with this type of appliance as with the traditional natural log or coal fire.

Rose & Portcullis

K39
22Kg



35185

W39.5 H53.5cm (15.5x21")

Phoenix

K18
40Kg



35225

W45.5 H56cm (18x22")

Ironfounder

K27
33Kg



35226

W48 H50.5cm (19x20")

Tree of Life

K9
35Kg



35186

W49.5 H73cm (19.5x28.75")

Two Cherubs

K36
48Kg



35227

W49.5 H68cm (19.5x26.75")

Royal Coat of Arms

K8
37Kg



35188

W53.5 H65.5cm (21x26")

Fleur-de-lys

K43F
21Kg



35184

W57.5 H41.5cm (22.5x16.5")

Lion

K43L
33Kg



35224

W59 H41.5cm (23.25x16.25")

Coat of Arms 1635

K6
36Kg



35128

W59.5 H51cm (23.5x20")

Shield

K20
40Kg



35229

W59 H57.5cm (23.25x22.5")

Plain

K6P
48Kg



35129

W60.5 H49.5cm (23.75x19.5")

Pikemen

K7
54Kg



35228

W59 H55cm (23.5x22")

Individual sizes & weights are provided for guidance only; due to the manufacturing process the actual product may vary.



Traditional Fire Backs - up to W76cm (30")



Brick-backed fireplace is protected by a K7 Pikemen cast iron Fireback with Barley Twist Dogs supporting a 24" Swansnest basket.

Rope Twist

K37
42Kg



35163

W66 H49.5cm (26x19.5")

Laughing Lion

K13
71Kg



35127

W72.5 H65cm (28.5x25.5")

Lion & Unicorn

K1
70Kg



35126

W73.5 H66cm (28.75x26")

Plain

K13P
57Kg



35140

W74 H66.5cm (29x26")

Horse Chestnut

K51
68Kg



35158

W74 H64.5cm (29.25x25.25")

Traditional Fire Backs - for the larger inglenook

Royal Oak Large

K22L
180Kg



35124
W107 H83.5cm (42x33.25")

K47
79Kg

Fairfax



35187
W86 H68.5cm (34x27")

K4
148Kg

Lion & Unicorn



35162
W96.5 H77.5cm (38.25x30.5")

Royal Oak Midi

K22
113Kg



35125
W84.5 H72cm (33.25x28.5")

K41L
114Kg

Medieval Large



35183
W87.5 H80.5cm (34.5x31.5")

Reeded Panels

Please note: The larger reeded panels and Fire backs featured on pages 58 - 60 are particularly heavy, therefore in the interests of Health & Safety we recommend 2/3 people are used to lift or move them.



Cross section showing Reeded form



The above wood-paneled fireplace interior is lined with cast iron Reeded Panels and a 24" Swansnest basket supported by Barley Twist Dogs.

Individual sizes & weights are provided for guidance only; due to the manufacturing process the actual product may vary.

Reeded Panels are used where the complete interior of the fireplace is required to be lined, as is the case of the re-building of a Georgian fireplace, or when reproducing a "period style fireplace".

35132 W40 H91.5cm (16x36") 41Kg

35133 W40 H101.5cm (16x40") 43Kg

35134 W45.5 H91.5cm (18x36") 46Kg

35135 W45.5 H101.5cm (18x40") 49Kg

35136 W76 H91.5cm (30x36") 78Kg

35137 W76 H101.5cm (30x40") 87Kg

35138 W122 H101.5cm (48x40") 145Kg

35139 W152.5 H101.5cm (60x40") 156Kg

Sizes approximate - please allow 12mm (1/2") tolerance. Thickness 15mm (+/- 3mm)

Traditional Firedogs

Firedogs are used as ornamental supports for Dog Grate/Baskets. Consideration should be given to the extra width required in a fireplace opening to accommodate the feet span of the dogs.

Cast Iron Dogs can, if preferred be used without a Dog Basket. Seasoned logs can be lent against the cross bars and burnt on the hearth base, providing there is a good draw in the chimney.

All Firedogs sold as pairs

Ball Head Dogs

G31



All Bar Heights 150mm (6"). All British Made Dogs dimensions may vary by 15mm due to hand crafting

Medium **34115**
W26 D52.5 H41.5cm
(10.25x20.75x16.25")

Column Dogs (Cast Iron)

G41



35164
W21 D46.5 H38cm
(8.25x18.25x15")
All Bar Heights 15cm (6")

Pinnacle Dogs (Cast Iron)

G36



35122
W19.5 D48.5 H40.5cm
(7.75x19x16")

All Bar Heights 15cm (6")

Barley Twist Dogs (Cast Iron)

G40



35123 W25.5 D46.5 H43cm
(10x18.25x17")

Ash Pans

All Heights 2cm

A20



- 34137** A20/A 16" Milner
- 34139** A20/C 11.5x9.25"
- 34141** A20/E 14.25x10.5"
- 34143** A20/G 17x10.5"
- 34146** A20/J 20.5x10.5"
- 34149** A20/M 18x15"

- 34138** A20/B 18" Milner
- 34140** A20/D 14.25x9.25"
- 34142** A20/F 15.75x10.5"
- 34145** A20/I 19.5x10.5"
- 34148** A20/L 25x15"
- 34151** A20/O 20x14"

Ashpan Covers

A21



- 34119** A21/02 14.75x4" **34120** A21/03 17.25x4"
- 34121** A21/04 21.25x4" **34127** A21/13 Unique
- 34130** A21/17 Unique **34131** A21/18 Unique

Where a cover is marked as 'Unique' it is NOT a rectangular shape and only fits the baskets indicated in the listing on the right.

Ash Pans

Dimensions for Ash Pans are category sizes relating to standard milner firebacks



Please Note;
Ash Pan maybe supplied in a steel or black finish and design may vary

- Ashpan with lifter
- 34078** W40cm (16")
- 34079** W45cm (18")

Ash Carriers



35074

Open Fire Ash Carrier to suit 16" & 18" Open Fires
W43 H33cm (17x13")

35075

Room Heater Ash Carrier to suit Charnwood, Parkray & Trianco
W40.5 H48cm (16x19")

35082

Open Fire Ash Carrier to suit 16" & 18" Open Fires
W43 H33cm (17x13") Black

Kettle



Weight
4Kg

35240

Kettle with Coil Handle
W26 D21 H23cm (10x8.25x9")

This item is water proof but is coated in a protective paint on the inside, therefore it is recommended for decorative use only.



Portcullis with Swan Neck & Back



G21

G21 with Fleur-de-Lys Back:
Standard **34191**
Medium **34194**
(Standard F-D-L shown):

G21 with Plain Back:
Standard **34192**

G21 with Lion Back:
Medium **34196**



Portcullis with Swan Neck **G20**



Dimensions:

Standard - W48.5 D35 H33.5cm (19x13.75x13.25")

Medium - W64 D35 H33.5cm (25.25x13.75x13.25")

Ashpans, Draught Covers and replacement Grids available - See attached table for details

G20 Basket:

Standard **34188** - Medium **34189**

When fitting the optional slot-in firebacks the overall height will increase by approx. 135mm (5.25") with the Standard size and approx. 19cm (7.5") with the Medium Sizes



G24

Ducksnest

G24 Dimensions:

Standard - W54.5 D27.5 H25cm (21.5x10.75x9.75")

Medium - W61.5 D33 H26cm (24.25x13x10.25")

Large - W75 D44 H28.5cm (29.5x17.25x11.25")

Ashpans, Covers and replacement Grids available - See attached table for details

Ducksnest for Dogs (Shown with British Ball Head Dogs) **G26**



G26 Dimensions:

Standard W62/54.5 D27.5 H15cm (24.5/21.5x10.75x6")

Medium W75/61.5 D33 H15cm (29.5/24.25x13x6")

Dimensions do not include Firedogs. Depending on choice, Firedogs will lift these baskets by 6-7" and extend the width by 6-12". Please see page 62 for Firedog dimensions.

G24 Basket: Standard **34109**

Medium **34110**

Large **34111**

G26 Ducksnest for Dogs: Standard **34112**

Medium **34113**

Detailed below for former Kingsworthy Products.

Easy reference guide for Ashpan, Draught Cover & Replacement Grid.

CODE	DESCRIPTION	ASHPAN	COVER	GRID
34103	G61 MINI POPULAR PLAIN	34140	34119	35174
34104	G61 STANDARD POPULAR PLAIN	34143	34120	1pr x 35173
34105	G61 MEDIUM POPULAR PLAIN	34146	34121	1pr x 35173 + 3 x 35144
34106	G14 MINI POPULAR - BLACK KNOBS	34140	34119	35174
34107	G14 STANDARD POPULAR - BLACK KNOBS	34143	34120	1pr x 35173
34108	G14 MEDIUM POPULAR - BLACK KNOBS	34146	34121	1pr x 35173 + 3 x 35144
34109	G24 STANDARD DUCKNEST	34139	34130	1 x 35171 + 6 x 35143
34110	G24 MEDIUM DUCKNEST	34142	34131	1pr x 35173 + 6 x 35144
34111	G24 LARGE DUCKNEST	34151	34127	2 X 35174
34112	G26 STANDARD DUCKNEST FOR DOGS		34120	1 x 35171 + 6 x 35143
34113	G26 MEDIUM DUCKNEST FOR DOGS		34121	1pr x 35173 + 6 x 35144
34152/53	G15 MINI POPULAR + VARIOUS FIREBACK OPTIONS	34140	34119	35174
34155/56	G15 STANDARD POPULAR + VARIOUS FIREBACK OPTIONS	34143	34120	1pr x 35173
34158/59	G15 MEDIUM POPULAR + VARIOUS FIREBACK OPTIONS	34146	34121	1pr x 35173 + 3 x 35144
34161/62	G63 MINI POPULAR PLAIN + VARIOUS FIREBACK OPTIONS	34140	34119	35174
34164/65	G63 STANDARD POPULAR PLAIN + VARIOUS FIREBACK OPTIONS	34143	34120	1pr x 35173
34167/68	G63 MEDIUM POPULAR PLAIN + VARIOUS FIREBACK OPTIONS	34146	34121	1pr x 35173 + 3 x 35144
34176	G68 MINI MODULA	34140	Inc	35174
34177	G68 STANDARD MODULA	34143	Inc	1pr x 35173
34178	G68 MEDIUM MODULA	34146	Inc	1pr x 35173 + 3 x 35144
34179/80	G69 MINI MODULA + VARIOUS FIREBACK OPTIONS	34140	Inc	35174
34182/83	G69 STANDARD MODULA + VARIOUS FIREBACK OPTIONS	34143	Inc	1pr x 35173
34185/86	G69 MEDIUM MODULA + VARIOUS FIREBACK OPTIONS	34146	Inc	1pr x 35173 + 3 x 35144
34188	G20 STANDARD PORTCULLIS WITH SWAN NECK	34141	34120	1pr x 35173
34189	G20 MEDIUM PORTCULLIS WITH SWAN NECK	34146	34121	1pr x 35173 + 3 x 35144
34191/92	G21 STANDARD PORTCULLIS WITH SWAN NECK + VARIOUS FB'S	34141	34120	1pr x 35173
34194/96	G21 MEDIUM PORTCULLIS WITH SWAN NECK + VARIOUS FB'S	34146	34121	1pr x 35173 + 3 x 35144



Popular - Black Knobs



G14

Dimensions:

Mini - W45 D29 H31cm (17.75x11.5x12.25")
Standard - W52 D34.5 H34.5cm (20.5x13.5x13.5")
Medium - W60.5 D34.5 H34.5cm (23.75x13.5x13.5")

Ashpans, Draught Covers and replacement Grids available - See Page 62 for details

G14 Basket:

Mini **34106** - Standard **34107** - Medium **34108**

When fitting the optional slot-in firebacks the overall height will increase by approx. 90mm (3.5") with the Mini size and approx. 135mm (5.25") with the Standard and Medium Sizes

Popular - Black Knobs with Back



G15



G15 with Fleur-de-Lys Back:

Mini **34152**
Standard **34155**
Medium **34158**
(Standard F-D-L shown)



G15 with Plain Back:

Mini **34153**
Standard **34156**
Medium **34159**

Popular Plain



G61

Dimensions:

Mini - W42 D27.5 H25cm (16.5x10.75x9.75")
Standard - W49 D33 H25cm (19.25x13x9.75")
Medium - W58 D34.5 H25cm (22.75x13.5x9.75")

Ashpans, Draught Covers and replacement Grids available - See Page 62 for details

G61 Basket:

Mini **34103** - Standard **34104** - Medium **34105**

When fitting the optional slot-in firebacks the overall height will increase by approx. 145mm (5.75") with the Mini size and approx. 235mm (9.25") with the Standard and Medium Sizes

Popular Plain with Back



G63



G63 with Fleur-de-Lys Back:

Mini **34161**
Standard **34164**
Medium **34167**



G63 with Plain Back:

Mini **34162**
Standard **34165**
Medium **34168**

Modula

Includes Draught Cover



G68

Dimensions:

Mini - W43 D28 H25.5cm (17x11x10")
Standard - W49.5 D33.5 H25.5cm (19.5x13.25x10")
Medium - W58.5 D33.5 H25.5cm (23x13.25x10")

Ashpans and replacement Grids available - See Page 62 for details

G68 Basket: Mini **34176** - Standard **34177** - Medium **34178**

When fitting the optional slot-in firebacks the overall height will increase by approx. 180mm (7") with the Mini size and approx. 260mm (10.25") with the Standard and Medium Sizes

Modula with Back

Includes Draught Cover



G69



G69 with Fleur-de-Lys Back:

Mini **34179**
Standard **34182**
Medium **34185**



G69 with Plain Back:

Mini **34180**
Standard **34183**
Medium **34186**
(Mini Plain shown):

Firebaskets

Spanish with Back



C9Std
23Kg



C9Med
28Kg

Combined Cover/Ashpan's sold separately.
Replacement Grids available.

C9 Standard **35176**
W47 D29 H45.5cm (18.5x11.5x18")
Combined Cover/Ashpan **35191**
Replacement Grid **35246**

C9 Medium **35177**
W54.5 D30 H46.5cm (21.5x11.75x18.25")
Combined Cover/Ashpan **35192**
Replacement Grid **35247**

Cromwell with Back

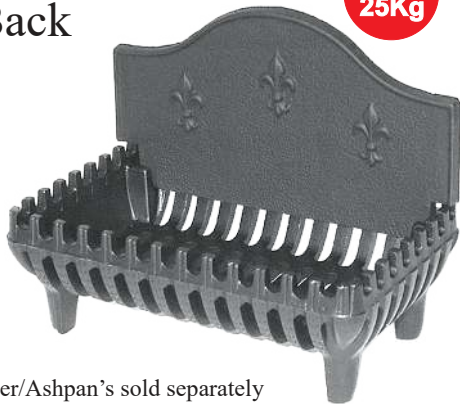

C11B
25Kg

Combined Cover/Ashpan's sold separately

C11B Standard **35239** W43 D27.5 H33.5 (17x10.75x13.25")
Combined Cover/Ashpan - Standard **35195**
(Fireback Only K60 **35161**)

Individual weights are provided for guidance only; the actual product may vary slightly.

Adam No.2



C2
40Kg

Cover sold separately

C2 Basket **35120** W57 D30 H63.5cm (22.5x13x25")
Cover **35193**

C12

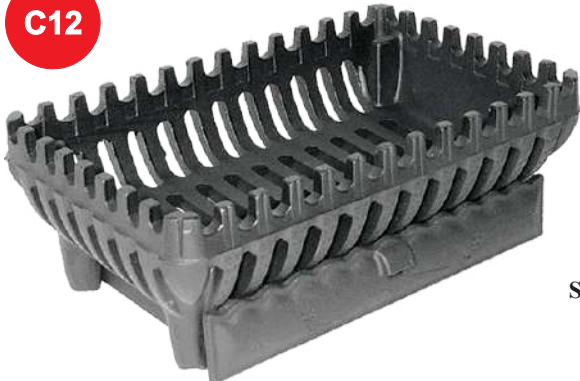

Cromwell

These weights are heavier than many other suppliers standard items.
Combined Cover/Ashpan's sold separately

Weights:
Standard - 11.5Kg
Large - 15.5Kg



C12 Standard **35241** W43 D27.5 H15cm (17x10.75x6")
C12 Large **35242** W53.5 D30.5 H15cm (21x12x6")
Combined Cover/Ashpan: Standard **35195** - Large **35196**

Small **35244** W37 D26 H16cm (14.5x10x6")
(This item does not come with a cover or ashpan)
Weight Small - 7Kg

Swansnest for dogs



Shown on G36 Pinnacle Dogs (not included) see page 60
Dimensions do not include firedogs

- C13 18" **35166** W44 D28 H16.5cm (17.25x11x6.5")
- C13 24" **35167** W59 D32 H16.5cm (23.25x12.5x6.5")
- C13 30" **35168** W73 D40.5 H16.5cm (28.75x16x6.5")
- C13 36" **35169** W90 D41.5 H16.5cm (35.5x16.25x6.5")

Swansnest freestanding

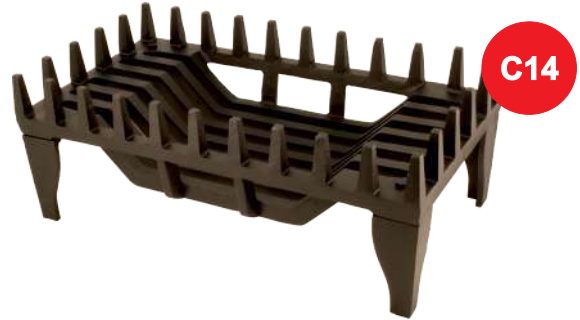

Supplied with Plain Legs as shown.
Dimensions as C13 range with Height increased to 24cm (9.5")

- With Plain Legs:
- C14 18" **35208**
 - C14 24" **35210**
 - C14 30" **35212**
 - C14 36" **35214**

Swansnest - 3 sided for dogs



Shown on G40 Barley Twist Dogs (not included) see page 60.
Dimensions do not include firedogs

- C20 18" **35145** W44.5 D30.5 H16.5cm (17.5x12x6.5")
- C20 24" **35146** W61 D35.5 H16.5cm (24x14x6.5")
- C20 30" **35147** W75 D41.5 H16.5cm (29.5x16.25x6.5")
- C20 36" **35148** W89 D41.5 H16.5cm (35x16.25x6.5")
- C20 42" **35149** W104 D41.5 H16.5cm (41x16.25x6.5")

Swansnest - 3 sided freestanding



Supplied with Plain Legs as shown.
Dimensions as C20 range with Height increased to 24cm (9.5")

- With Plain Legs:
- C21 18" **35198**
 - C21 24" **35200**
 - C21 30" **35202**
 - C21 36" **35204**
 - C21 42" **35206**

Log Cradle for dogs



Shown on G41 Column Dogs (not included) see page 60
Use with bar at front or back.
Dimensions do not include firedogs

- C30 18" **35155** W44.5 D30.5 H10cm (17.5x12x4")
- C30 24" **35156** W61 D35.5 H10cm (24x14x4")
- C30 30" **35157** W75 D41.5 H10cm (29.5x16.25x4")

Log Cradle freestanding



Supplied with Plain Legs as shown.
Dimensions as C30 range with Height increased to 16.5cm (6.5")
Use with bar at front or back

- Plain Legs:
- C31 18" **35216**
 - C31 24" **35218**
 - C31 30" **35220**

Castle



35090

W57 D28 H44cm (22x11x17")
Solid Fuel Kit **SFK22C 35114**

Solid Fuel Kit
sold separately

Valencia



Solid Fuel Kits
sold separately

16" **35099** W40 D33 H22cm. Solid Fuel Kit SFK23 **35110**
18" **35100** W47 D33.5 H22cm. Solid Fuel Kit SFK12 **35112**
21" **35101** W55 D33 H22cm. Solid Fuel Kit SFK14 **35116**

Individual sizes & weights are provided for guidance only; due to the manufacturing process the actual product may vary.



Elan

Solid Fuel Kit
sold separately

35040

Black Elan With Back
W46 D30.5 H41cm
(18x12x16")

35112

Solid Fuel Kit SFK12

The Matrix



Solid Fuel Kit
sold separately

35093

Black
W51.5 D30 H39.5cm
(20x12x15.5")

35116

Solid Fuel Kit SFK14

Krypton



Solid Fuel Kit
sold separately

35091

Black
W53.5 D26 H19cm
(21x10.25x7.5")

35115

Solid Fuel Kit SFK22K



Solid Fuel Kit
sold separately

35092

Polished
W53.5 D26 H19cm
(21x10.25x7.5")

35115

Solid Fuel Kit SFK22K

Polished firebaskets are not recommended for use with solid fuel

Polished surface can also discolour when used with a gas fire

Fire Grates

Regal

35001

W40cm (16")

Regal 16"
Width Front 38cm
Width Back 25.5cm
Sides 24cm



Guardette Grate

35004

W40cm (16")

35005

W45cm (18")

Guardette 16"
Width Front 39cm
Width Back 24.5cm
Sides 21cm
Guardette 18"
Width Front 44cm
Width Back 31.5cm
Sides 23cm



Joyce Grate & Front

35002

W40cm (16")

35003

W45cm (18")

Joyce 16"
Width Front 38cm
Width Back 24.5cm
Sides 22cm
Joyce 18"
Width Front 42cm
Width Back 29.5cm
Sides 22cm



Standard Grate

35006

W40cm (16")

35007

W45cm (18")

Standard 16"
Width Front 37.5cm
Width Back 25cm
Sides 20cm
Standard 18"
Width Front 43cm
Width Back 30cm
Sides 20cm



Milner Grids



35141 40.5cm (16")

WF31.5xWB21.5xD20.8cm
(12.5x8.5x8.25")

35142 45.5cm (18")

WF36.1xWB26.1xD20.8cm
(14.25x10.25x8.25")

Loose Bars

Used in conjunction with
Rectangular Grids on some baskets.



35143

Standard 25x3cm (9.75x1.25")

35144

Medium 28x3cm (11x1.25")

Rectangular Grids

See list on right for details of which
grid is used on which basket

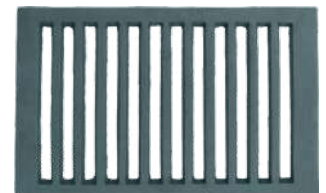

35171 A18 Ref.B 39.5x24cm (15.5x9.5")

35172 A18 Ref.C 45.5x30.5cm (18x12")

35173 A18 Ref.F (Sold in pairs) each one
measures 21.5x28cm (8.5x11")

35174 A18 Ref.G 37.5x22cm (14.75x8.75")

35246 C09 18" Spanish Grid (15x9.5")

35247 C09 21" Spanish Grid (18x9.5")

Beacon Solid Fuel Kit



Includes Beacon Fret, Grate & Ashpan

35076 W40cm (16")

35104 W45cm (18")

Ash pan may vary in style

Style Solid Fuel Kit



Includes Style Fret, Grate & Ashpan

35080 W40cm (16")

35102 W45cm (18")

Ash pan may vary in style

Castle Solid Fuel Kit



Includes Castle Fret, Grate & Ashpan

35103 W40cm (16")

35107 W45cm (18")

Ash pan may vary in style

N Type Solid Fuel Kit



Includes N Type Fret, Grate & Ashpan

35108 W40cm (16")

35109 W45cm (18")

Ash pan may vary in style

Windsor Inset



- 35130** 16" Windsor Inset
- 34078** 16" Replacement Ash Pan
- 35130G** 16" Replacement Grid

Dimensions:
16"- W40.5/20 D28 H22cm (16/9.5x11x8.75")

- 35131** 18" Windsor Inset
- 34079** 18" Replacement Ash Pan
- 35131G** 18" Replacement Grid

Dimensions:
18"- W45.5/28.5 D28.5 H22cm (18/11.25x11.25x8.75")

Includes Windsor Fret, Grate, Ashpan & Draught Cover. Ashpan may vary in style

Castle



- Black**
- 33070** W40cm (16") H19cm (7.5")
 - 33072** W45cm (18") H20cm (8")

N Type



- Black**
- 33066** W40cm (16") H14cm (5.5")
 - 33068** W45cm (18") H14cm (5.5")

Style



- Black**
- 33074** W40cm (16") H23cm (8.75")
 - 33075** W45cm (18") H23cm (8.75")

Beacon

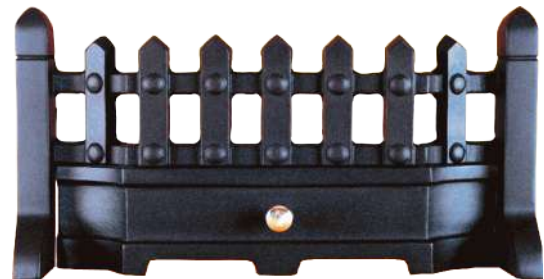

- Black**
- 33021** W40cm (16") H20cm (8")
 - 33024** W45cm (18") H20cm (8")

Frets & Solid Fuel

Aviva

Measurements for all Aviva Frets Height: 21.5cm (8.5")



Black
33095 W40cm (16")



Chrome
33096 W40cm (16")

Brass
33098 W40cm (16")



Satin Chrome
33097 W40cm (16")



Daisy

Measurements for all Daisy Frets Width: 40cm (16") Height: 22cm (8.75")



Black
33085



Brass
33086



Chrome
33088



Black & Chrome
33089



Black & Brass
33087

Bauhaus

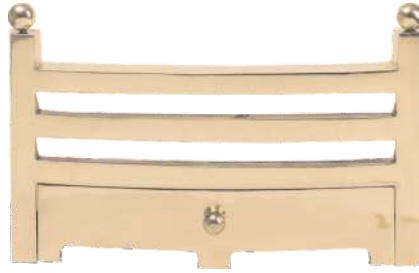

With the Bauhaus Fret choose a black finish for use with solid fuel as polished surfaces change colour with heat. Polished surfaces can also be affected by the heat from gas appliances, although the resultant discolouration will be much less noticeable.

Black Cast Iron

33043 W40cm (16") H26cm (10.25")

33046 W45cm (18") H27cm (10.5")

Antique

33045 W40cm (16")

H26cm (10.25")

Polished

33044 W40cm (16") H26cm (10.25")

Blenheim

Measurements for all Blenheim Frets Width: 40cm (16") Height: 19cm (8.5")



Black Cast Iron

33011

Chrome

33077

Black & Brass

33015

Grace

Measurements for all Grace Frets Width: 40cm (16") Height: 20.5cm (8")



Black
33079

Chrome
33081

Brass
33080



British Club Fenders - Key: BB = Brass Backs fitted as standard. MES = Minimum extending size possible.

Antique Brass & Satin Chrome finishes now available or any combination i.e. Black & Satin Chrome



Spiral Black

Illustrated seat colour is Burgundy, with a black finish
 Made to measure only, (122cm) 4' minimum width.
 3 row 'deep' buttons as standard.
 Seat size shown approx 16.5x52cm (W6.5"H20.5")

Incorporating the finest quality hide with close attention to detail, the Club range offers the perfect solution for an exclusive fireside setting. With a range of seat covers including Burgundy, Antique Green, Antique Red, Burnt Copper, Earth Brown, Ocean Blue and Black. Seat styles can be varied to suit personal requirements with models illustrated depicting standard seat designs. For reasons of stability, we recommend a minimum base return of 12"(30cm). We will be pleased to provide a quotation for special sizes and configurations which can be manufactured to your requirements. Optional Brass Backs are available on all models, with the exception of the Regal Club and Spiral Black but are fitted as standard on the Canterbury.



Majestic

Illustrated seat colour is Ocean Blue, with a Brass finish.
 MES (122x152.5cm) 4/5' .3 row 'float' buttons as standard.
 Seat size shown approx 19.5x51cm (W7.75"H20")



Mini Majestic

Illustrated seat colour is Burgundy, with a Brass finish.
 MES 4/5'. 2 row 'float' buttons as standard.
 Seat size shown approx 16.5x25.4cm (W6.5"H14")



Illustrated seat colour is Burgundy with a Brass finish



Illustrated seat colour is Ocean Blue with a Satin Chrome finish



Illustrated seat colour is Earth Brown with a Antique Brass finish

Regal

MES (1220x1525mm) 4/5'. Unbuttoned as standard. Seat size shown approx 16.5x46cm (W6.5"H18")

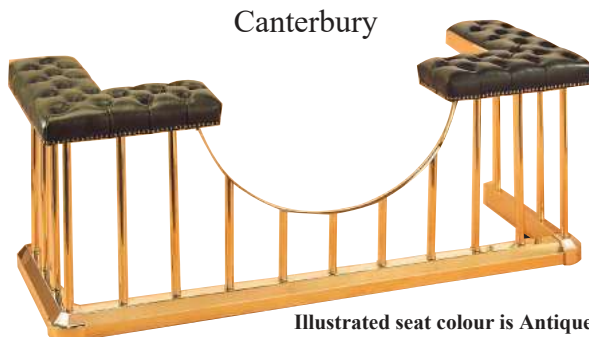

Canterbury

Illustrated seat colour is Antique Green with a Brass finish
 Made to measure only, (122cm) 4' minimum width.
 3 row 'deep' buttons as standard.
 BB Seat size shown approx 16.5x46cm (W6.5"H18")

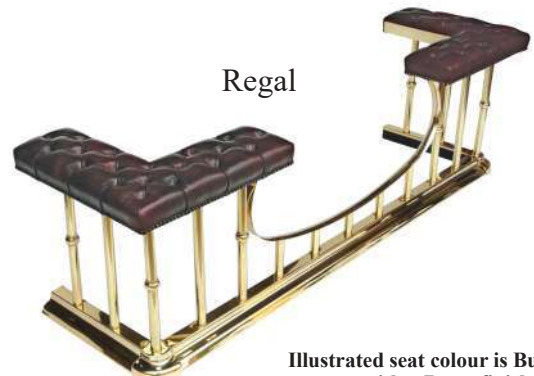

Regal

Illustrated seat colour is Burgundy with a Brass finish

Made to measure only. 5' (152.5cm) minimum width.
 3 row 'deep' buttons as standard. Seat size shown approx 16.5x52cm (W6.5"H20.5")



British Fenders

All standard fenders have INTERNAL dimensions of 122/152.5 x 38cm (4/5'x15"), unless otherwise stated. We offer a bespoke service where width and depth dimensions as well as various finish options can be provided. Base only dimensions H5cm D5cm.



Classic 6 Brass
30045



Classic 6 Black & Brass
30055



Classic 6 Black & Silver
30065



Classic 6 Silver
30075



To ensure goods are received in perfect condition, the fenders on this page are supplied in 3 pieces for easy showroom or home fitting.



British Fenders

All standard fenders have INTERNAL dimensions of 122/152.5 x 38cm (4/5'x15"), unless otherwise stated. We offer a bespoke service where width and depth dimensions as well as various finish options can be provided.

Classic Base Brass
30035



Classic Base Black
30255



Classic Base Steel
30085



Classic Base Fenders - Base only dimensions H5cm D5cm



To ensure goods are received in perfect condition, the fenders on this page are supplied in 3 pieces for easy showroom or home fitting.

Regal Base Brass
30095



Regal Base Black
30115



Regal Base Steel
30105



Regal Base Fenders - Base only dimensions H5cm D7.5cm

All standard fenders have INTERNAL dimensions of 122/152.5 x38cm (4/5'x15"), unless otherwise stated. The fenders offered on this page are only available in standard sizes and finishes.
All Base dimensions H6.5cm D6.5cm, Height to top of Bars H13cm

6 Urn - 3 Piece



31000
Black

6 Ball - 3 Piece



31002
Black

6 Ball - 3 Piece

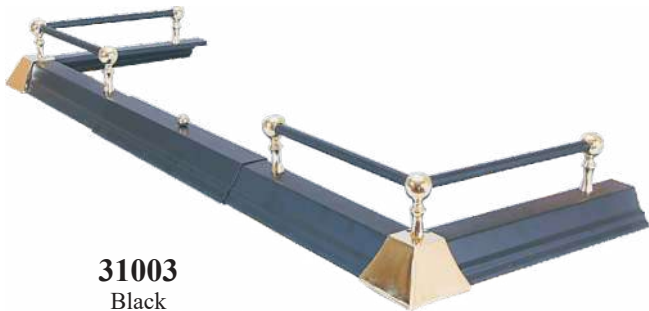

31003
Black
& Brass

Spiral Twist - 3 Piece



31004
Black

Plain Base - 3 Piece



31006
Black

6 Ball - 3 Piece



31007
Black &
Satin Nickel

Candle Lanterns



Candles not included

24004

Set of 3 Indoor/Outdoor
Brushed Gold Round Lanterns

Large
H52.5 Dia32cm
(20.5"x12.5")
Height with
handle 68cm

Medium
H44.5 Dia27cm
(17.5"x10.5")
Height with
handle 57.5cm

Small
H42 Dia24cm
(16.5"x9.5")
Height with
handle 53.5cm



Candles not included

24003

Set of 3 Indoor/Outdoor
Brushed Gold Square Lanterns

Small
H35 W27 D27cm
(13.75"x10.5"x10.5")
Height with
handle 45cm

Medium
H40 W32 D32cm
(15.75"x12.5"x12.5")
Height with
handle 55cm

Large
H45 W37 D37cm
(17.75"x14.5"x14.5")
Height with
handle 63cm



24010

Boot Rack
H52.5 W56.5 D23cm
(20.5"x22.25"x9")

NEW



24009

Wall Planter Galvanised
W10 Dia 40cm
(4"x15.75")

NEW

Elevate the aesthetic of your room or outdoor area with our range of decorative tree, metal wall art. The lightweight nature of this product makes it effortless to install. With it's elegant design and contemporary charm, the wall art is the perfect centrepiece for any room. Attach to the wall using the built in installation features, some of the wall arts already have drilled holes for installation and some you may have to drill new holes.

Items with the standard powder coating can be used outdoors as well as indoors but when using outdoors these will go rusty over time. Items with the natural rust finish are useable indoor and outdoor.

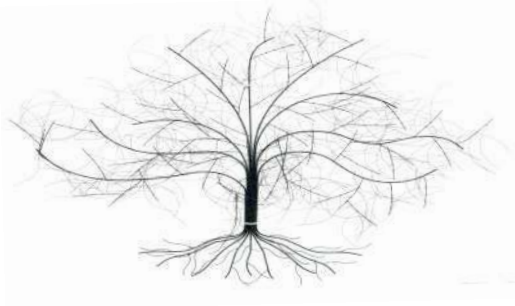

24000
W100 H76cm
Standard Powder coating



24001
W100 H54cm
Standard Powder coating



24002
W83 H69cm
Standard Powder coating



24005
W59.5 H75.5cm
Natural rust finish

NEW



24006
Dia 70.5cm
Natural rust finish

NEW



24007
W82 H75.5cm
Natural rust finish

NEW

The Calcube



British manufactured using 3mm mild steel. Available in two sizes, delivered flat packed, no nuts or bolts and only takes two minutes to slot together.

Calcube One Fire Basket
H:30 x D:30 x W:30cm (12x12x12")
38022

Calcube Two Fire Basket
H:30 x D:30 x W:45cm (12x12x18")
38023

Premium Fire Bowls



Large
Dia:69 H:31cm (27x12")
38014



Medium
Dia:57 H:31cm (22x12")
38015



Small
Dia:39.5 H:29.5cm
(15.5x11.5")
38016

Large BBQ Rack
38018

Small/Medium BBQ Rack
38019

Premium Fire Bowls made from 1.5mm steel and powdered coated for extra protection.

The Standard bowl is available in three sizes and the Stool Bowl is only available in a medium.

Also Available is the BBQ grille so you can cook your favourites at the same time.

Stool Fire Bowl
Dia:57.5 H:29.5cm
(22.5x11.5")
38017



Welcome to the CALFIRE FIRESIDE COLLECTION.

CALFIRE is a long established family group of companies with a strong reputation for quality products and service throughout the heating and fireplace industry. Friendly and approachable, CALFIRE prides itself on customer service.

In November 2010 CALFIRE, took over the supply and distribution of the exceptional Kingsworthy Foundry range of fireside accessories for log and coal burning fires. As a result, CALFIRE now offer the most comprehensive range of quality cast iron firebacks, firebaskets, swansnest baskets, ducksnest baskets, firedogs and reeded panels together with superb quality British Made steel firebaskets and blacksmith produced firedogs.

CALFIRE are unique within the fireplace and heating industry with their extensive product related ranges. In addition to offering a most comprehensive selection of Fireside Accessories they are also:

- ✎ The official UK distributor for StoveBright® High-Temperature Paint, selling the product in aerosol and touch-up forms to retailers as well as in bulk liquid form to many of the leading UK traditional Woodburning Stove Manufacturers. Visit the UK specific StoveBright® website at www.stovebright.co.uk for full information.
- ✎ The official UK distributor for Ecofans®. These products sit on the top of woodburning stoves and assist in distributing the stoves heat without using mains or battery power. Improved warm air circulation results in greater comfort and less fuel consumption. Ecofans® are a great favourite with the countries many Narrow Boat enthusiasts. Visit the UK specific Ecofan® website at www.ecofan.co.uk for full information.
- ✎ A major supplier of Replacement Stove Glass offering Schott Robax Ceramic Glass panels, Borofloat Strips as well as Mica. All popular sizes are available 'off the shelf' with in house facilities available for cutting your special requirements.

Terms & Conditions of Sale

1 GENERAL

These conditions shall apply to all of our quotations and all contracts, and orders for the sale of goods accepted by us. Any other terms, conditions, warranties or representations, whether made prior to collateral with, or subsequent to the contract or order, are hereby excluded. Special or additional terms of the purchaser contained in his order or otherwise shall be of no effect unless the same be separately brought to our notice and express consent thereto is given in our written acceptance.

2 DOCUMENTS

- a) All literature, illustrations, drawings, specifications, weights, measure, technical data, estimates of performance that we supply have been prepared by the Manufacturers of the goods and accordingly we cannot accept any liability for any inaccuracy, omission, variation of any kind or for any loss howsoever caused arising out of the supply of such and they shall not form part of any contract or be binding in any way.
- b) We reserve the right at any time to correct clerical or technical errors in the contract documents.
- c) The purchaser shall furnish us with all necessary specifications with the order. We take no responsibility for goods manufactured, price, or delivery not in accordance with the order or the specification or any requirements of any Government or other inspecting authority. It is the purchaser's duty to check that any technical information supplied by us and any particulars included in our acknowledgment confirming those specifications are correctly set out.

3 PRICES

Quotations only refer to goods and articles specified therein and available at the time of quotation. All selling prices contained in the quotation are ex-works except where expressly altered within the quotation, are net and exclude VAT and are those ruling at the date of quotation. They are provisional only and are subject to revision by us at any time without notice before the goods are despatched to take into account of subsequent variations in the cost of materials, labour, awards or increases in overhead cost. Prices may also be revised where the purchaser calls down quantities smaller than those specified in his order. The purchaser shall pay the price as so revised. VAT shall be charged at the appropriate rate in force at the time of invoicing.

4 TERMS OF PAYMENT

- a) Unless otherwise stipulated on our invoice, all accounts are strictly net monthly account.
 - b) Where the contract is to be or may be fulfilled in separate installments, deliveries or parts, payment for such installment, delivery or part shall be made under sub-clause (a) hereof as if the same constituted a separate contract.
 - c) Should the purchaser fail punctually with the terms of payment, we shall be entitled to charge interest on any overdue account at the rate of 2½% over and above the Midland Bank Base rate charged per month.
- ### 5 TITLE
- a) Title to the product shall not pass to the purchaser until payment has been received in full by us of (i) the price thereof and (ii) all other sums owing to us.
 - b) Until payment of all such sums, the purchaser shall hold the products as agent for us and shall store them on his premises separately from his own goods or those of any other person and in a manner, which makes them readily identifiable as our goods.
 - c) The purchaser may sell the goods as agent and bailee for us, but as against any third party the sale by the purchaser shall be as in principal such of the proceeds of any sale as is equal to the price to the purchaser of the goods shall be held in trust for us and shall not be mingled with any other monies or paid into an overdrawn bank account and shall at all times be identifiable as our money.
 - d) If the goods are admitted, consumed, converted or otherwise become constituents of other goods the property of the purchaser before payment has been received by us and before title to the goods has passed to the purchaser, the goods, including all of any such other goods, shall be the property of us and the purchaser declares itself a trustee of such goods for us until such payment is made in full to us and the purchaser shall hold such goods and the entire proceeds of sale and any rights arising from the sale thereof as trustee for us.
 - e) If at any time before title of the goods shall have passed to the purchaser we may, for the purpose of recovery of the goods, enter upon any premises where the goods are stored, or where they are reasonably thought to be stored, and may repossess them and the purchaser grants us such licences as may be necessary for the purpose of entry to any premises of the purchaser.

6 TIME OF DESPATCH

All periods for despatch and delivery expressed in the contract are approximate only. We use all reasonable endeavours to effect despatches within the stipulated period, or if no such period be stipulated, within a reasonable amount of time. However, we shall be under no liability for any loss or damage to the purchaser or others arising directly or indirectly out of late despatch or delivery, whether due to our default or not, nor shall such late despatch or delivery be deemed to be breach of contract, nor entitle the purchaser to cancel the contract.

7 DELIVERY

- a) When delivery is effected on our vehicles or by an independent contractor arranged by us, the purchaser having had prior notification, shall be bound to accept delivery of the goods on arrival at his works, when sole risk in the goods shall pass to the purchaser. Where payment in full has not been received the purchaser as agents shall, on delivery, insure and keep fully insured the goods against all and every risk, including specifically but without prejudice to the generality of the foregoing damage by the purchaser or third parties, fires, explosion, aircraft, theft, tempest and flood; and the purchaser shall also be responsible for the maintenance and care of the goods and, in addition to indemnifying us against any depreciation in the value of the goods, shall also indemnify us against any damage caused to the goods should payment in full not be made.
- b) The purchaser to notify us and the carrier in writing (otherwise than upon the carrier's documents), of any damage in transit, mis-delivery, or quantity discrepancy immediately on arrival. The purchaser must notify us and their carrier in writing (otherwise than on the carrier's documents) of any non-delivery within 5 working days where delivery is effected through the post, by road or British Rail, and 2 working days where delivery is effected on our own vehicles; in all cases from the date of despatch advised to the purchaser.
- c) Where delivery is effected on the purchaser's vehicle or is arranged by him, risk in the goods shall pass to the purchaser on delivery to the carrier, whether he be the purchaser's servant or agent or an independent contractor arranged by the purchaser.
- d) Without prejudice to our other rights, should the purchaser for any reason fail to accept delivery of the goods on arrival (prior notification having been made) then, at the entire risk and expenses of the purchaser, we shall be entitled to store the goods and/or to procure or effect storage of goods elsewhere and we shall further be entitled to be paid by the purchaser for the cost of re-delivery and storage of goods.
- e) To stop any delivery (prior notification having been made) the purchaser must give in writing 7 working days notice.

8 RETURNED GOODS

We cannot accept the return of goods already delivered to the purchaser otherwise than pursuant to clause 7 (c) hereof or by special arrangement, and then subject to the appropriate restocking charge which shall not be less than 10% of the net invoice value.

9 INDEMNITY

The purchaser shall indemnify us against all actions, claims, demands, penalties and cost by third parties in tort, or for infringement or alleged infringements of patents or registered designs or otherwise arising in connection with the goods or their delivery or unloading or with work done by us in accordance with the purchasers specifications.

10 EXCLUSION OF LIABILITY

We are hereby expressly excluded from any liability howsoever arising in respect of any express or implied condition, statement, representation or warranty, statutory or otherwise relating to any goods supplied by us. However, without prejudice to the foregoing, we are prepared to assist in the execution of any Manufacturer's warranties and guarantees.

11 INSOLVENCY

If the purchaser shall make default in, or commit any breach of, any of his obligations to us (whether under this agreement or otherwise), or wrongfully stop payment of any debt, or is deemed to be unable to pay its debts within the meaning of such Insolvency Act as shall be current at the date of the contract, and if any distress or execution should be levied upon the purchaser, his property or assets, or if the purchaser shall make or offer to make any arrangements or composition with creditors to commit any act of bankruptcy, or if any petition or receiving order in bankruptcy shall be presented or made against the purchaser, or if the purchaser shall be a limited company and any resolution or petition to wind up such company's business shall be passed or presented (otherwise than for reconstruction or amalgamation only), or if a receiver of such company's undertaking property or assets or any part thereof shall be appointed then in any such case we shall have the right forthwith to determine the contract in whole or in part by notice in writing to the purchaser and repossess any of the goods of which title has not passed to the purchaser pursuant to condition 5 hereof.

12 MISCELLANEOUS

- a) The granting of this, or the neglect or forbearance on the part of us in enforcing any of these conditions, shall neither be nor be deemed to be, a waiver or in any way prejudice any right of us under these conditions.
- b) If any term, paragraph or provision of these conditions shall be held to be invalid or unenforceable for whatever reason, such invalidity or unenforceability shall not affect the operation of any other term, paragraph or provision.
- c) This contract applies to further purchases that the purchaser makes and shall be govern in accordance with the laws of England and we and the purchaser both submit to the jurisdiction of the English courts.
- e) If any part of this contract shall be rendered invalid by operation of law then, to the extent allowed by law, the remainder of this contract shall remain in force and such part of this contract as has been rendered inoperable shall be deemed to be replaced by a clause of similar nature and effect but to the extent allowed by law.

Major UK Wholesaler of
Fireside Accessories, Service
& Maintenance Products



Official UK Distributors
for the Caframo Ecofan



Official UK Distributors
for Stove Bright HD Paint



Stove Bright

Major UK Supplier of
Schott Robax Stove Glass

SCHOTT
ROBAX®



www.calfire.com

 01691 772922

Calfire Spareline Ltd, Gledrid, Chirk, Wrexham LL14 5DG